

Каталог продукции MEGADYNE

Технические характеристики

По вопросам продаж и поддержки обращайтесь:

Архангельск (8182)63-90-72	Калининград (4012)72-03-81	Нижний Новгород (831)429-08-12	Смоленск (4812)29-41-54
Астана +7(7172)727-132	Калуга (4842)92-23-67	Новокузнецк (3843)20-46-81	Сочи (862)225-72-31
Белгород (4722)40-23-64	Кемерово (3842)65-04-62	Новосибирск (383)227-86-73	Ставрополь (8652)20-65-13
Брянск (4832)59-03-52	Киров (8332)68-02-04	Орел (4862)44-53-42	Тверь (4822)63-31-35
Владивосток (423)249-28-31	Краснодар (861)203-40-90	Оренбург (3532)37-68-04	Томск (3822)98-41-53
Волгоград (844)278-03-48	Красноярск (391)204-63-61	Пенза (8412)22-31-16	Тула (4872)74-02-29
Вологда (8172)26-41-59	Курск (4712)77-13-04	Пермь (342)205-81-47	Тюмень (3452)66-21-18
Воронеж (473)204-51-73	Липецк (4742)52-20-81	Ростов-на-Дону (863)308-18-15	Ульяновск (8422)24-23-59
Екатеринбург (343)384-55-89	Магнитогорск (3519)55-03-13	Рязань (4912)46-61-64	Уфа (347)229-48-12
Иваново (4932)77-34-06	Москва (495)268-04-70	Самара (846)206-03-16	Челябинск (351)202-03-61
Ижевск (3412)26-03-58	Мурманск (8152)59-64-93	Санкт-Петербург (812)309-46-40	Череповец (8202)49-02-64
Казань (843)206-01-48	Набережные Челны (8552)20-53-41	Саратов (845)249-38-78	Ярославль (4852)69-52-93

TABLE OF CONTENTS

Production centres 2



PLATINUM 6



MEGAFLEX
PU truly endless timing belts 43



ISORAN® SYNCHRONOUS BELTS
Rubber endless timing belts 11



MEGARIB
PU endless Megarib belts 47



OPEN-END RUBBER
SYNCHRONOUS BELTS 17



SPECIAL
Any special pitches,
custom made coatings and profiles 49



V-BELTS
Rubber V-belts 19



PULLEYS / CLAMPING PLATES
Custom made and standard pulleys
and clamping plate 51



PV V-RIBBED BELTS
Rubber belts 31



MEGAWELD
Thermoweldable belts 53



MEGAFLAT
PU and rubber endless flat belts 33



ACCULINK® 54



MEGAPOWER
PU endless timing belts 35



PPJ System 55



MEGALINEAR
PU open-end timing belts in rubber 39

Megadyne catalogues 56



PRODUCTION CENTRES

Megadyne commenced manufacturing transmission belts in 1957. Constant research and development has resulted in the creation of a large range of quality products. This places **Megadyne** as one of the worlds leading producers of polyurethane belts, rubber belts and pulleys, offering a complete drive system to the market.

Megadyne products are suitable for most industrial drive applications, for power transmission, synchronisation, conveying and linear positioning. Manufacturing plants are located in Mathi (Italy), St. Jean de Maurienne (France), Ulm (Germany), Milan (Italy), Pineville (USA), Bondoufle (France), Barcelona (Spain) and Wuxi (China).

Megadyne mission statement is: "To constantly strive and achieve the best possible product for all industrial applications". **Megadyne** Research and Development department is in constant collaboration with our Customer's Technical departments, supporting existing projects and helping to develop new ones. Our aim is to satisfy all aspects of our Customer's requirements. In order to give technical support our R & D department is constantly researching new materials and regularly updating production technology. In this way new product development is achieved more efficiently.

Local service and technical support are guaranteed by a worldwide distribution network. Megadyne continually expands its global presence through master distributors network. Moreover **Megadyne** is directly present in:

MEGADYNE s.p.a. - Mathi (TO) - ITALY

MEGADYNE NORDIC AB - Sollentuna - SWEDEN

MEGADYNE AMERICA LLC - Pineville NC - USA

MEGADYNE CE - Bydgoszcz - POLAND

MEGADYNE CHINA - Foshan Guangdong - CHINA

MEGADYNE CZ - Prague - CZECH REPUBLIC

MEGADYNE DO BRASIL LTDA - San Paulo - BRAZIL

MEGADYNE EE - Minsk - BELARUS

MEGADYNE FRANCE - Bondoufle - FRANCE

MEGADYNE GmbH - Borchten - GERMANY

MEGADYNE HU KFT - Budapest - HUNGARY

MEGADYNE RUBBER - Vilanova I La Geltrü

(Barcelona) - SPAIN

MEGADYNE S&D - Robassomero (TO) - ITALY

MEGADYNE UK - Dudley - UK

Headquarters - Mathi (ITALY)

Full range Polyurethane Timing belts production



Megadyne Rubber SA - Barcelona (SPAIN)

Production of high quality rubber timing, PV and V-belts



Megadyne S&D s.r.l. - Milan (ITALY)

Production plant for standard and special pulleys



PRODUCTION CENTRES

Megadyne America LLC - Pineville (USA)
Polyurethane open-end timing belts production



Megadyne China - Ningbo (CHINA)
Rubber V-belt production



Megadyne China - Qingdao (CHINA)
Polyurethane extruded belts production



Megadyne France SA - Bondoufle (FRANCE)
Special pulleys production



Megadyne France - S.te Jean de Maurienne (FRANCE)
Polyurethane moulded endless timing belts production



Megadyne GmbH - Ulm (GERMANY)
Polyurethane and rubber endless flat belts production



In North America, Jason Industrial Inc. has been a trusted name for Industrial Rubber, Urethane and Thermoplastic Solutions for over 50 years.

As a Manufacturer and Marketer, **Jason Industrial** has grown exponentially producing and supplying V-belts, Synchronous belts, Sheaves & Bushings, Industrial Hose, Couplings and Skirtboard Rubber to Industrial and Power Transmission Distributors and Original Equipment Manufacturers.

Jason Industrial is directly present in:

JASON INDUSTRIAL INC. - Fairfield - NJ - USA
 JASON Distribution Center - Carol Stream - IL - USA
 JASON INDUSTRIAL INC. - Irving - TX - USA
 JASON INDUSTRIAL INC. - Los Angeles - CA - USA
 JASON INDUSTRIAL INC. - Tampa - FL - USA
 JASON INDUSTRIAL INC. - Portland - OR - USA

JASON DO BRASIL LTDA - Sorocaba - Sao Paulo - BRAZIL
 JASON INDUSTRIAL CANADA LTD - Quebec - CANADA
 JASON INDUSTRIAL CANADA LTD - Ontario - CANADA
 JASON INDUSTRIAL CANADA LTD - Alberta - CANADA
 JASON INDUSTRIAL S.DER.L.DEC.V. Azcapotzalco - MEXICO

Corporate Office-Fairfield - NJ (USA)



Central Warehouse - Carol Stream - IL (USA)



T.B.M.C. - Greenville - SC (USA)
 Production plant for rubber timing belt



For your Industrial Hose & Coupling needs, **Jason** offers a wide selection of Rubber, Thermoplastic and PVC Hose for application in Air, Food Processing, Water, Petro-Chemical and Mining. Pre-coupled and packaged lengths of PVC and Rubber Air Hose, Mill Hose and Jackhammer Hose is readily available from all **Jason Industrial** warehouses. **Jason** also maintains a vast line of Cam & Groove Couplings, Clamps, Pin Lugs, Flanges, Nozzles, Nipples, Strainers and related accessories.



In June 2008, **Jason** moved into a new 56,000 sq. ft. Distribution Center in Carol Stream, IL. This brand new facility will provide rapid inventory replenishment of existing Jason warehouses coupled with streamlined ordering and daily direct shipments of complete Hose & Coupling orders to a growing number of existing and new distributors in North America.



PLATINUM

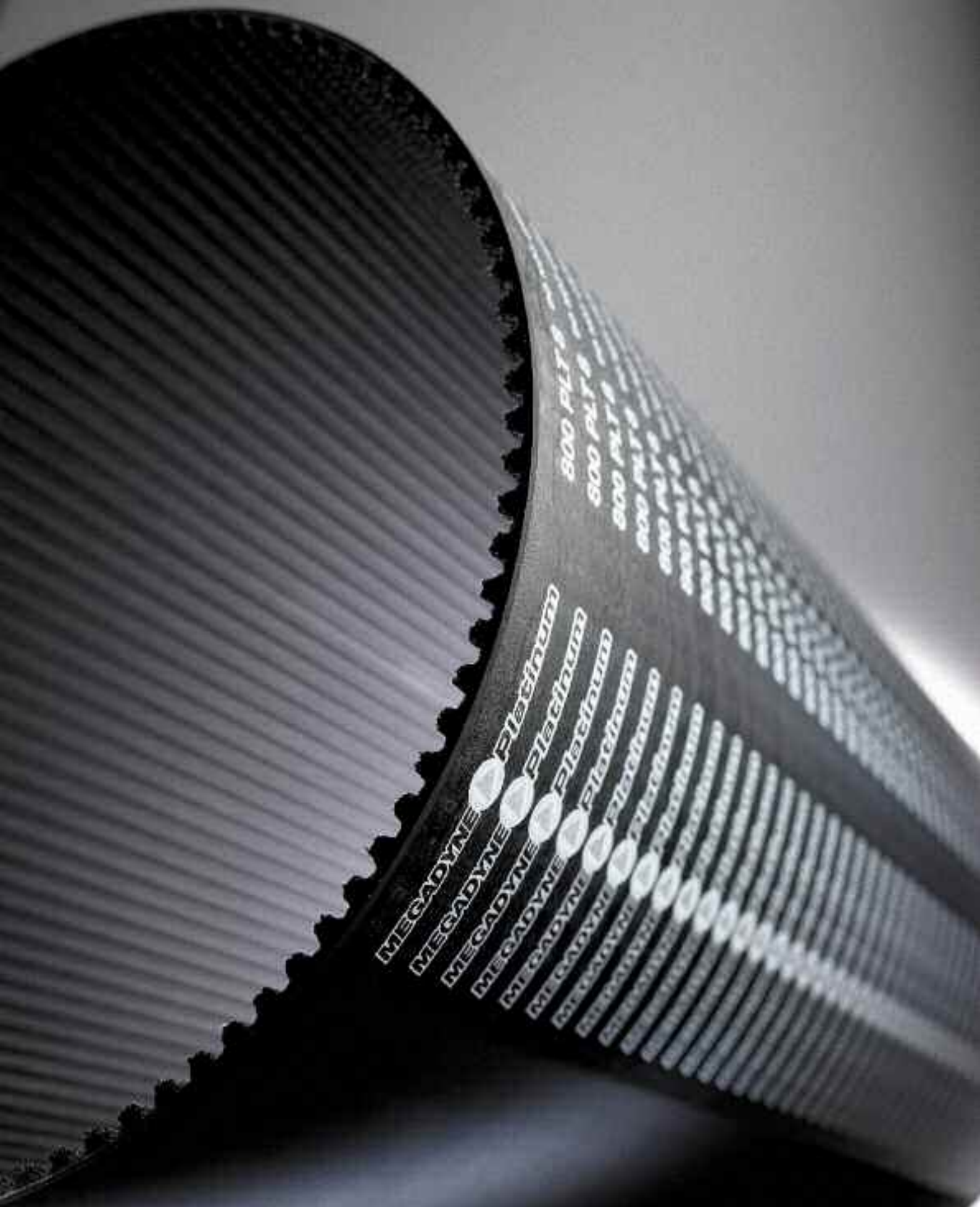

Megadyne proudly introduces the new **PLATINUM** timing belt drive, the latest development on hi-performance systems, which significantly improve the "specific power" capacity and offer new application opportunities against alternative systems like gears, chains that always have a disadvantage in terms of weight, noise, lubrication and maintenance costs.

The starting point was the long experience cumulated with the existing **RPP GOLD** line, well known and consolidated in the marketplace. We improved its even good characteristics, keeping fixed two basic assumptions:

- **develop a new belt/system always in rubber to minimise or not change the noise level of the new drives;**
- **retain the parabolic design of teeth profile to guarantee an easy up-grade of the existing drives, in the spirit and concept of interchange ability which identified, along the last years, our market approach philosophy.**

In general every belt component contribute to improve the global mechanical resistance, minimising the risk of belt break or failure and granting a bigger "specific power" capacity, that means higher basic design performance. However, the tensile cords of the belt have a significant role to improve the power performance, because they support tension loads always bigger. Today hi-performance timing belts are built with tensile cords made by steel or aramide fibres.

Aramide fibres, as well known, have a very poor dimensional stability over the lifetime, thus a timing belt made with this type of tensile cords will have problems in their length (pitch) stability, which will have a negative impact on lifetime, because the meshing error that is generated with the pulleys. On the other side, tensile cords made in steel have an excellent rigidity and dimensional stability over the lifetime, but the belt will have a very high specific weight. Furthermore, usage of steel cords in association with conventional process for rubber belt assembly, generate so many extra problems to make this type of construction unaffordable.

The new **PLATINUM** is a rubber based timing belt, which solve the problems related to steel and aramide cords, thanks to the development and usage of its innovative "Dual Core" hybrid cord technology. **PLATINUM** reach the highest level of performances incorporating this cord in a new rubber matrix and covering the teeth with a special and unique heavy fabric.

FEATURES

Thanks to the innovative materials used, **PLATINUM** is a reliable, lower maintenance and economical alternative to drive systems with chains and gears; it's particularly recommended for efficient, compact drives with high or pulse torque loads, offering:

- Increased basic power capacity by up to 40% compared to the current RPP GOLD;
- Use of existing RPP pulleys, maintaining a full functional interchange with other deep pulley profile systems, like HTD, etc.
- Allows existing drives to be upgraded without the necessity to replace the pulleys, just the belt itself.
- Reduction of noise by reduced belt widths due to the higher performance rating of the system. Under the same transmission conditions, **PLATINUM** has the same noise level of RPP GOLD;
- Low noise characteristics compared to drive systems using polyurethane, steel etc. due to the rubber matrix and its teeth with the parabolic profile shape, recognised as the quietest system on the market
- A wide, continuous range of possible operating temperature, like no other system, which makes **PLATINUM** the only solution for extreme working conditions.

PLATINUM

STRUCTURE

The new PLATINUM is made with the most innovative materials of the highest quality. The extensive development and tests performed has resulted in the homogeneous integration of all the components, the cohesive bond of which imparts superior load capacity to PLATINUM, providing to the users the maximum performance level nowadays available:

- the highest belt tension and length stability;
- longer drive lifetime due to the higher power capacity and flex fatigue resistance;
- more compact and lightweight drives under the same power ratings;
- exceptional resistance to abrasion and tooth shear under pulse loads;
- full functional interchange with all the other major deep pulley profile systems;
- no stocking and packaging constraints.

THE BELT BODY 1 4

An innovative design and blend of HNBR elastomers, uniquely cross-linked to increase teeth rigidity and shear resistance, up to +25% in comparison to GOLD belts. Despite the high levels of rigidity and hardness, this compound guarantees an exceptional resistance to flex fatigue, preventing the appearance of cracks when working with very small pulleys.

Tests made have showed an incredible improvement in the flex fatigue resistance up to 10 times more than the previous Gold version, running on the smallest pulley diameters under the same load conditions.

Furthermore this compound is formulated to considerably resist the effects of mineral oils (test conditions 22h at 100°C in ASTM3 oil; -25% less absorption than GOLD), offering an incredible wide range of working temperatures: from -35° C to +115° C.

TENSION MEMBERS 2

The tensile member is made out of the innovative "Dual Core" hybrid cord technology and it constitutes the load carrying elements inside the New PLATINUM belt.

The "Dual Core" technology gives excellent characteristics to this cord, which grant to PLATINUM extreme dimension stability under static and dynamic tensions, joined with a superior flex fatigue resistance.

These performances can eliminate any kind of re-tensioning procedure, providing a real maintenance-free operation and guarantying always a perfect tooth meshing for long lasting service with reduction of abrasion, vibrations and noise.

The higher elastic modulus of PLATINUM, on average +25% rigid than GOLD, and its superior flexibility, allows consequently more compact drives and durability.

TOOTH FACING FABRIC 3

A hard-wearing polyamide fabric is bonded to the tooth surface, to improve torque carrying capacity and tooth shear resistance. Its special surface impregnation process confers self-lubricating properties, a lower friction and increased drive efficiency.



The PLATINUM belt is defined by the following parameters [figure 1]:

BELT PITCH:

the distance P in millimeters between two adjacent tooth centres as measured along the pitch line of the belt.

BELT PITCH LENGTH:

the total length (circumference) of the belt in millimeters as measured along the pitch line (the theoretical pitch line of PLATINUM lies within the tensile member).

The pitch length is a parameter that identifies univocally a synchronous drive belt; to measure a belt it's necessary a suitable measuring equipment, as specified in the standard ISO/FDIS 13050:1999(E).

BELT WIDTH:

the width of the belt measured in millimeters.

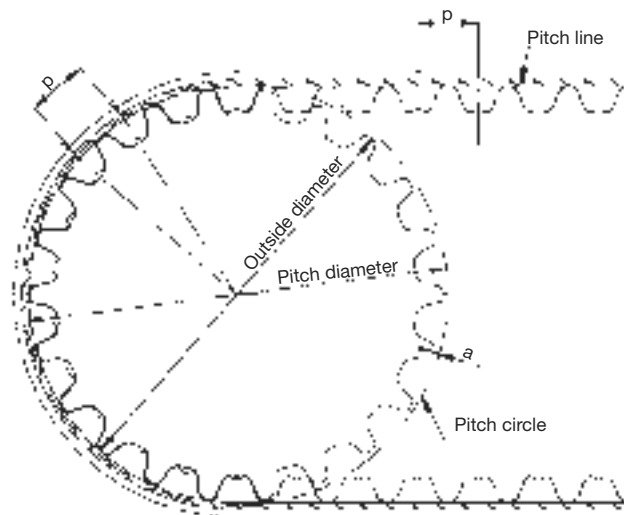
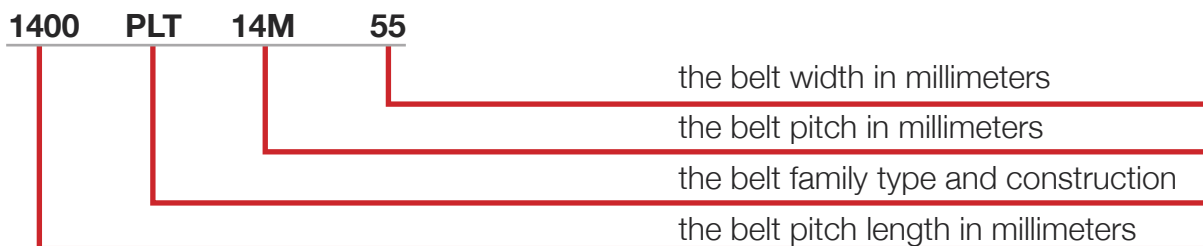

Figure 1

The new PLATINUM belt is consequently identified and coded as follow:



PLATINUM

The new **PLATINUM** belts adopt by default for their teeth shape, the innovative RPC parabolic profile, an evolution of the well know RPP profile, of which retains the basic principle, enlarging meanwhile the interchange possibility with also all those pulleys having a deep groove profile of latest generation.

RPC maintain the basic parabolic design of teeth profile to guarantee an easy up-grade of the existing RPP drives, in the spirit and concept of full drive interchange, thus the RPC based PLATINUM system will continue to work perfectly on the current RPP pulleys.

The **PLATINUM** nominal belt tooth shape and reference are shown given in Figure 2, while the dimension data are listed below in Table Dimensions for each available pitch.

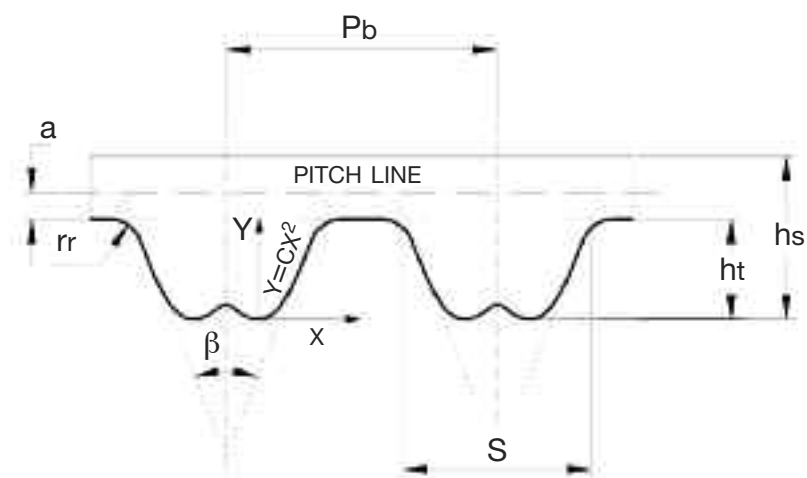

Figure 2

TABLE DIMENSIONS

Belt type	Pitch	β	S	h_s	h_t	r_r	a
8M	8mm	32°	5.4	5.4	3.46	0.85	0.8
14M	14mm	32°	9.5	9.7	6.1	1.5	1.4

ISORAN® SYNCHRONOUS BELTS
Rubber endless timing belts



ISORAN® SYNCHRONOUS BELTS

Rubber endless timing belts



MEGADYNE RUBBER timing belts are available with single or double Sided teeth, in classical and RPP profiles. They are manufactured using the most advanced technology available.

ISORAN® CLASSICAL SYNCHRONOUS MXL XL L H XH XXH

- Trapezoidal tooth profile
- Polychloroprene teeth for accurate meshing
- Fiberglass reinforcement for minimal elongation
- Nylon fabric protecting tooth surface

ISORAN RPP3 RPP5 RPP8 RPP14 RPP20

- RPP parabolic tooth profile gives graduated pressure increase over tooth height
- Fiberglass reinforcement for minimal elongation and high flexibility
- Chloroprene rubber for wear resistance and increased service life
- Nylon fabric protecting tooth surface, with self lubrication



The new synchronous belts ISORAN RPP SILVER and RPP GOLD are constructed with the highest quality materials.

The bonded strength of all components guarantees superior torque capacity. The ISORAN RPP SILVER increases load carrying capacity up to 10% compared to previous RPP Plus, while the ISORAN RPP GOLD increases up to 30% compared to the RPP Panther.

ISORAN RPP SILVER and RPP GOLD advantages:

- Upgrade the existing transmission without changing the pulleys
- Perfect interchangeability with parabolic and deep pulley profile
- Antistatic Properties conforming to the BS 2050
- Drive energy efficiency up to 98%
- Excellent for backside idlers
- Higher tooth jump resistance
- Increased resistance to tooth shear
- Quiet, maintenance-free operation

ISORAN RPP SILVER are available in pitches 5, 8 and 14 mm. RPP GOLD are available in pitches 8 and 14 mm (on request 5 mm).

RPP® 5 SILVER DD, RPP® 8 SILVER DD and RPP® 14 SILVER DD are produceable on request.

RPP® GOLD DD: on request.



ISORAN® SYNCHRONOUS BELTS

Rubber endless timing belts

RPP3 - RPP5 - RPP8 - RPP14
RPP20 - RPP5 SILVER
RPP8 SILVER - RPP14 SILVER
RPP8 GOLD - RPP14 GOLD

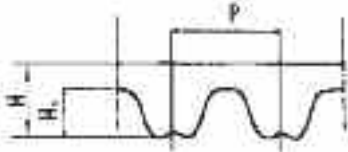

RPP3	
Code	Pitch length (mm)
90 RPP3	90
105 RPP3	105
129 RPP3	129
141 RPP3	141
144 RPP3	144
147 RPP3	147
150 RPP3	150
159 RPP3	159
168 RPP3	168
174 RPP3	174
177 RPP3	177
180 RPP3	180
186 RPP3	186
195 RPP3	195
201 RPP3	201
204 RPP3	204
210 RPP3	210
213 RPP3	213
225 RPP3	225
231 RPP3	231
240 RPP3	240
243 RPP3	243
246 RPP3	246
249 RPP3	249
252 RPP3	252
255 RPP3	255
261 RPP3	261
264 RPP3	264
267 RPP3	267
270 RPP3	270
276 RPP3	276
285 RPP3	285
288 RPP3	288
291 RPP3	291
297 RPP3	297
300 RPP3	300
312 RPP3	312
318 RPP3	318
327 RPP3	327
330 RPP3	330
333 RPP3	333
336 RPP3	336
339 RPP3	339
345 RPP3	345
357 RPP3	357
363 RPP3	363
375 RPP3	375
384 RPP3	384
390 RPP3	390
393 RPP3	393
405 RPP3	405
420 RPP3	420
432 RPP3	432
447 RPP3	447
474 RPP3	474
480 RPP3	480
486 RPP3	486
489 RPP3	489
495 RPP3	495
501 RPP3	501
510 RPP3	510
513 RPP3	513
522 RPP3	522
531 RPP3	531
537 RPP3	537
564 RPP3	564
570 RPP3	570
576 RPP3	576
579 RPP3	579
582 RPP3	582
597 RPP3	597
600 RPP3	600
633 RPP3	633
648 RPP3	648
669 RPP3	669
711 RPP3	711
735 RPP3	735
738 RPP3	738
756 RPP3	756
804 RPP3	804
882 RPP3	882
945 RPP3	945

RPP3	
Code	Pitch length (mm)
1062 RPP3	1062
1125 RPP3	1125
1245 RPP3	1245
1263 RPP3	1263
1500 RPP3	1500
1530 RPP3	1530
1863 RPP3	1863
P	3
H ₁	1,15
H	2,4

RPP5	
Code	Pitch length (mm)
180 RPP5	180
225 RPP5	225
235 RPP5	235
245 RPP5	245
255 RPP5	255
265 RPP5	265
270 RPP5	270
280 RPP5	280
285 RPP5	285
295 RPP5	295
300 RPP5	300
305 RPP5	305
325 RPP5	325
345 RPP5	345
350 RPP5	350
375 RPP5	375
400 RPP5	400
420 RPP5	420
425 RPP5	425
450 RPP5	450
455 RPP5	455
460 RPP5	460
465 RPP5	465
475 RPP5	475
500 RPP5	500
525 RPP5	525
535 RPP5	535
565 RPP5	565
575 RPP5	575
580 RPP5	580
600 RPP5	600
610 RPP5	610
615 RPP5	615
635 RPP5	635
640 RPP5	640
670 RPP5	670
675 RPP5	675
700 RPP5	700
705 RPP5	705
710 RPP5	710
725 RPP5	725
740 RPP5	740
750 RPP5	750
755 RPP5	755
800 RPP5	800
835 RPP5	835
850 RPP5	850
890 RPP5	890
900 RPP5	900
935 RPP5	935
940 RPP5	940
950 RPP5	950
980 RPP5	980
1000 RPP5	1000
1025 RPP5	1025
1050 RPP5	1050
1100 RPP5	1100
1125 RPP5	1125
1135 RPP5	1135
1195 RPP5	1195
1200 RPP5	1200
1240 RPP5	1240
1270 RPP5	1270
1420 RPP5	1420
1500 RPP5	1500
1595 RPP5	1595
1605 RPP5	1605
1690 RPP5	1690
1790 RPP5	1790
1800 RPP5	1800
1870 RPP5	1870
1895 RPP5	1895
1945 RPP5	1945
2000 RPP5	2000
2250 RPP5	2250
2525 RPP5	2525
P	5
H ₁	2
H	3,8

RPP8	
Code	Pitch length (mm)
288 RPP8	288
320 RPP8	320
352 RPP8	352
360 RPP8	360
384 RPP8	384
408 RPP8	408
416 RPP8	416
456 RPP8	456
480 RPP8	480
536 RPP8	536
544 RPP8	544
560 RPP8	560
600 RPP8	600
608 RPP8	608
632 RPP8	632
640 RPP8	640
680 RPP8	680
720 RPP8	720
760 RPP8	760
800 RPP8	800
840 RPP8	840
880 RPP8	880
896 RPP8	896
920 RPP8	920
960 RPP8	960
1000 RPP8	1000
1040 RPP8	1040
1080 RPP8	1080
1120 RPP8	1120
1200 RPP8	1200
1224 RPP8	1224
1280 RPP8	1280
1352 RPP8	1352
1424 RPP8	1424
1440 RPP8	1440
1464 RPP8	1464
1600 RPP8	1600
1680 RPP8	1680
1760 RPP8	1760
1800 RPP8	1800
1904 RPP8	1904
2000 RPP8	2000
2200 RPP8	2200
2272 RPP8	2272
2400 RPP8	2400
2520 RPP8	2520
2600 RPP8	2600
2800 RPP8	2800
3048 RPP8	3048
3280 RPP8	3280
3600 RPP8	3600
4400 RPP8	4400
P	8
H ₁	3,2
H	5,4

ISORAN® SYNCHRONOUS BELTS

Rubber endless timing belts

RPP14	
Code	Pitch length (mm)
966 RPP14	966
994 RPP14	994
1092 RPP14	1092
1106 RPP14	1106
1190 RPP14	1190
1260 RPP14	1260
1288 RPP14	1288
1344 RPP14	1344
1400 RPP14	1400
1442 RPP14	1442
1568 RPP14	1568
1610 RPP14	1610
1750 RPP14	1750
1764 RPP14	1764
1778 RPP14	1778
1848 RPP14	1848
1890 RPP14	1890
1904 RPP14	1904
1960 RPP14	1960
2100 RPP14	2100
2240 RPP14	2240
2310 RPP14	2310
2380 RPP14	2380
2450 RPP14	2450
2590 RPP14	2590
2660 RPP14	2660
2800 RPP14	2800
2968 RPP14	2968
3150 RPP14	3150
3360 RPP14	3360
3500 RPP14	3500
3850 RPP14	3850
3920 RPP14	3920
4326 RPP14	4326
4578 RPP14	4578
4956 RPP14	4956

P	14
H ₁	6
H	9,7

RPP20	
Code	Pitch length (mm)
2000 RPP20	2000
2500 RPP20	2500
3400 RPP20	3400
3800 RPP20	3800
4200 RPP20	4200
4600 RPP20	4600

P	20
H ₁	8,3
H	14,5

RPP5 SILVER	
Code	Pitch length (mm)
180-SLV5	180
225-SLV5	225
235-SLV5	235
245-SLV5	245
255-SLV5	255
265-SLV5	265
270-SLV5	270
280-SLV5	280
285-SLV5	285
295-SLV5	295
300-SLV5	300
305-SLV5	305
325-SLV5	325
345-SLV5	345
350-SLV5	350
375-SLV5	375
400-SLV5	400
420-SLV5	420
425-SLV5	425
450-SLV5	450
455-SLV5	455
460-SLV5	460
465-SLV5	465
475-SLV5	475
500-SLV5	500
525-SLV5	525
535-SLV5	535
565-SLV5	565
575-SLV5	575
580-SLV5	580
600-SLV5	600
610-SLV5	610
615-SLV5	615
635-SLV5	635
640-SLV5	640
670-SLV5	670
675-SLV5	675
700-SLV5	700
705-SLV5	705
710-SLV5	710
725-SLV5	725
740-SLV5	740
750-SLV5	750
755-SLV5	755
800-SLV5	800
835-SLV5	835
850-SLV5	850
890-SLV5	890
900-SLV5	900
935-SLV5	935
940-SLV5	940
950-SLV5	950
980-SLV5	980
1000-SLV5	1000
1025-SLV5	1025
1050-SLV5	1050
1100-SLV5	1100
1125-SLV5	1125
1135-SLV5	1135
1195-SLV5	1195
1200-SLV5	1200
1240-SLV5	1240
1270-SLV5	1270
1420-SLV5	1420
1500-SLV5	1500
1595-SLV5	1595
1605-SLV5	1605
1690-SLV5	1690
1790-SLV5	1790
1800-SLV5	1800
1870-SLV5	1870
1895-SLV5	1895
1945-SLV5	1945
2000-SLV5	2000
2250-SLV5	2250
2525-SLV5	2525

P	5
H ₁	2
H	3,8

RPP8 SILVER	
Code	Pitch length (mm)
288-SLV8	288
320-SLV8	320
352-SLV8	352
360-SLV8	360
384-SLV8	384
408-SLV8	408
416-SLV8	416
456-SLV8	456
480-SLV8	480
536-SLV8	536
544-SLV8	544
560-SLV8	560
600-SLV8	600
608-SLV8	608
632-SLV8	632
640-SLV8	640
680-SLV8	680
720-SLV8	720
800-SLV8	800
840-SLV8	840
880-SLV8	880
896-SLV8	896
920-SLV8	920
960-SLV8	960
1000-SLV8	1000
1040-SLV8	1040
1080-SLV8	1080
1120-SLV8	1120
1200-SLV8	1200
1224-SLV8	1224
1280-SLV8	1280
1352-SLV8	1352
1424-SLV8	1424
1440-SLV8	1440
1464-SLV8	1464
1600-SLV8	1600
1680-SLV8	1680
1760-SLV8	1760
1800-SLV8	1800
2000-SLV8	2000
2200-SLV8	2200
2272-SLV8	2272
2400-SLV8	2400
2520-SLV8	2520
2600-SLV8	2600
2800-SLV8	2800
3048-SLV8	3048
3280-SLV8	3280
3600-SLV8	3600
4400-SLV8	4400

P	8
H ₁	3,2
H	5,4

RPP14 SILVER	
Code	Pitch length (mm)
966-SLV14	966
994-SLV14	994
1092-SLV14	1092
1106-SLV14	1106
1190-SLV14	1190
1260-SLV14	1260
1288-SLV14	1288
1344-SLV14	1344
1400-SLV14	1400
1442-SLV14	1442
1568-SLV14	1568
1610-SLV14	1610
1750-SLV14	1750
1764-SLV14	1764
1778-SLV14	1778
1848-SLV14	1848
1890-SLV14	1890
1904-SLV14	1904
1960-SLV14	1960
2100-SLV14	2100
2240-SLV14	2240
2310-SLV14	2310
2380-SLV14	2380
2450-SLV14	2450
2590-SLV14	2590
2660-SLV14	2660
2800-SLV14	2800
2968-SLV14	2968
3150-SLV14	3150
3360-SLV14	3360
3500-SLV14	3500
3850-SLV14	3850
3920-SLV14	3920
4326-SLV14	4326
4578-SLV14	4578
4956-SLV14	4956

P	14
H ₁	6
H	9,7

RPP8 GOLD	
Code	Pitch length (mm)
288-GLD8	288
320-GLD8	320
352-GLD8	352
360-GLD8	360
384-GLD8	384
408-GLD8	408
416-GLD8	416
456-GLD8	456
480-GLD8	480
536-GLD8	536
544-GLD8	544
560-GLD8	560
600-GLD8	600
608-GLD8	608
632-GLD8	632
640-GLD8	640
680-GLD8	680
720-GLD8	720
800-GLD8	800
840-GLD8	840
880-GLD8	880
896-GLD8	896
920-GLD8	920
960-GLD8	960
1000-GLD8	1000
1040-GLD8	1040
1080-GLD8	1080
1120-GLD8	1120
1200-GLD8	1200
1224-GLD8	1224
1280-GLD8	1280
1352-GLD8	1352
1424-GLD8	1424
1440-GLD8	1440
1464-GLD8	1464
1600-GLD8	1600
1680-GLD8	1680
1760-GLD8	1760
1800-GLD8	1800
2000-GLD8	2000
2200-GLD8	2200
2272-GLD8	2272
2400-GLD8	2400
2520-GLD8	2520
2600-GLD8	2600
2800-GLD8	2800
3048-GLD8	3048
3280-GLD8	3280
3600-GLD8	3600
4400-GLD8	4400

P	8
H ₁	3,2
H	5,4

RPP14 GOLD	
Code	Pitch length (mm)
966-GLD14	966
994-GLD14	994
1092-GLD14	1092
1106-GLD14	1106
1190-GLD14	1190
1260-GLD14	1260
1288-GLD14	1288
1344-GLD14	1344
1400-GLD14	1400
1442-GLD14	1442
1568-GLD14	1568
1610-GLD14	1610
1750-GLD14	1750
1764-GLD14	1764
1778-GLD14	1778
1848-GLD14	1848
1890-GLD14	1890
1904-GLD14	1904
1960-GLD14	1960
2100-GLD14	2100
2240-GLD14	2240
2310-GLD14	2310
2380-GLD14	2380
2450-GLD14	2450
2590-GLD14	2590
2660-GLD14	2660
2800-GLD14	2800
2968-GLD14	2968
3150-GLD14	3150
3360-GLD14	3360
3500-GLD14	3500
3850-GLD14	3850
3920-GLD14	3920
4326-GLD14	4326
4578-GLD14	4578
4956-GLD14	4956

P	14
H ₁	6
H	9,7



ISORAN® SYNCHRONOUS BELTS

Rubber endless timing belts

MXL - XL - L - H - XXH

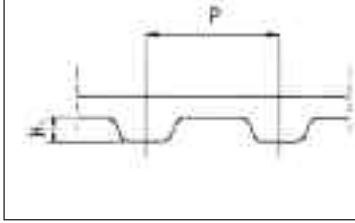

XLDD - LDD - HDD

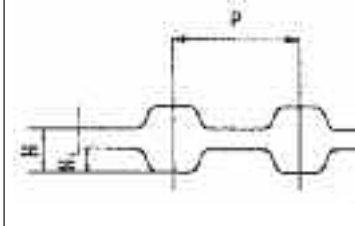

RPP5 DD - RPP8 DD - RPP14 DD

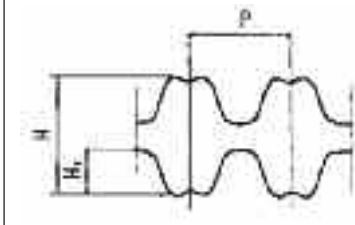

MXL	
Code	Pitch length (mm)
360 MXL	91,44
432 MXL	109,73
440 MXL	111,76
456 MXL	115,82
480 MXL	121,92
488 MXL	123,95
496 MXL	125,98
536 MXL	136,14
544 MXL	138,18
576 MXL	146,30
584 MXL	148,34
608 MXL	154,43
632 MXL	160,53
640 MXL	162,56
656 MXL	166,62
664 MXL	168,66
680 MXL	172,72
704 MXL	178,82
720 MXL	182,88
736 MXL	186,94
752 MXL	191,00
760 MXL	193,04
776 MXL	197,10
800 MXL	203,20
808 MXL	205,23
824 MXL	209,30
840 MXL	213,36
880 MXL	223,52
888 MXL	225,55
912 MXL	231,65
920 MXL	233,68
944 MXL	239,78
952 MXL	241,81
960 MXL	243,84
976 MXL	247,90
984 MXL	249,94
1000 MXL	254,00
1008 MXL	256,03
1016 MXL	258,06
1040 MXL	264,16
1056 MXL	268,22
1072 MXL	272,29
1120 MXL	284,48
1160 MXL	294,64
1176 MXL	298,70
1184 MXL	300,74
1200 MXL	304,80
1224 MXL	310,90
1280 MXL	325,12
1400 MXL	355,60
1472 MXL	373,89
1496 MXL	379,98
1520 MXL	386,08
1600 MXL	406,40
1680 MXL	426,72
1696 MXL	430,78
1768 MXL	449,07
1800 MXL	457,20
1832 MXL	465,33
1856 MXL	471,42
1888 MXL	479,55
1984 MXL	503,94
1992 MXL	505,97
2048 MXL	520,19
2240 MXL	568,96
2360 MXL	599,44
2384 MXL	605,54
2480 MXL	629,92
2496 MXL	633,98
2520 MXL	640,08
2584 MXL	656,34
2776 MXL	705,10
2864 MXL	727,46
2880 MXL	731,52
2976 MXL	755,90
3064 MXL	778,26
3104 MXL	788,42
3200 MXL	812,80
3296 MXL	837,18
3424 MXL	869,70
3472 MXL	881,89
3480 MXL	883,92

MXL	
Code	Pitch length (mm)
3520 MXL	894,08
3632 MXL	922,53
3704 MXL	940,82
3944 MXL	1001,78
4000 MXL	1016,00
4064 MXL	1032,26
4200 MXL	1066,80
4280 MXL	1087,12
4320 MXL	1097,28
4456 MXL	1131,82
4736 MXL	1202,94
4800 MXL	1219,20
5224 MXL	1326,90

P	2,032
H _i	0,51
H	1,14

XL	
Code	Pitch length (mm)
54 XL	137,16
60 XL	152,40
70 XL	177,80
80 XL	203,20
90 XL	228,60
98 XL	248,92
100 XL	254,00
102 XL	259,08
104 XL	264,16
106 XL	269,24
110 XL	279,40
120 XL	304,80
130 XL	330,20
140 XL	355,60
146 XL	370,84
150 XL	381,00
156 XL	396,24
160 XL	406,40
170 XL	431,80
176 XL	447,04
180 XL	457,20
182 XL	462,28
188 XL	477,52
190 XL	482,60
198 XL	502,92
200 XL	508,00
202 XL	513,08
210 XL	533,40
212 XL	538,48
214 XL	543,56
220 XL	558,80
228 XL	579,12
230 XL	584,20
234 XL	594,36
240 XL	609,60
250 XL	635,00
260 XL	660,40
270 XL	685,80
276 XL	701,04
290 XL	736,60
310 XL	787,40
316 XL	802,64
320 XL	812,80
330 XL	838,20
344 XL	873,76
352 XL	894,08
364 XL	924,56
380 XL	965,20
384 XL	975,36
388 XL	985,52
390 XL	990,60
392 XL	995,68
434 XL	1102,36
460 XL	1168,40
530 XL	1346,20
600 XL	1524,00
710 XL	1803,40

P	5,08
H _i	1,27
H	2,4

L	
Code	Pitch length (mm)
124 L	314,96
135 L	342,90
150 L	381,00
173 L	439,42
187 L	476,25
202 L	513,80
210 L	533,40
225 L	571,50
240 L	609,60
255 L	647,70
270 L	685,80
285 L	723,90
300 L	762,00
322 L	819,15
334 L	848,36
345 L	876,30
367 L	933,45
390 L	990,60
405 L	1028,70
412 L	1047,75
420 L	1066,80
450 L	1143,00
480 L	1219,20
510 L	1295,40
540 L	1371,60
600 L	1524,00
728 L	1847,85
817 L	2076,45

P	9,525
H _i	1,91
H	3,6

XH	
Code	Pitch length (mm)
507 XH	1289,00
534 XH	1356,36
560 XH	1422,40
630 XH	1600,20
700 XH	1778,00
770 XH	1955,80
840 XH	2133,60
980 XH	2489,20
1120 XH	2844,80
1260 XH	3200,40
1400 XH	3566,00
1540 XH	3911,60
1750 XH	4445,00

P	22,225
H _i	6,22
H	11,4

H	
Code	Pitch length (mm)
240 H	609,60
270 H	685,80
300 H	762,00
330 H	838,00
360 H	914,40
390 H	990,60
420 H	1066,80
450 H	1143,00
480 H	1219,20
510 H	1295,40
540 H	1371,60
570 H	1447,80
600 H	1524,00
630 H	1600,20
660 H	1676,40
670 H	1701,80
700 H	1778,00
725 H	1841,50
750 H	1905,00
800 H	2032,00
850 H	2159,00
900 H	2286,00
1000 H	2540,00
1100 H	2794,00
1120 H	2844,80
1140 H	2895,60
1150 H	2921,00
1250 H	3175,00
1400 H	3556,00
1645 H	4178,30
1700 H	4318,00

P	12,7
H _i	2,29
H	4,4

XXH	
Code	Pitch length (mm)
700 XXH	1778,0
800 XXH	2032,0
900 XXH	2286,0
1000 XXH	2540,0
1200 XXH	3048,0
1400 XXH	3556,0
1600 XXH	4064,0
1800 XXH	4572,0

P	31,75
H _i	9,53
H	15,3

ISORAN® SYNCHRONOUS BELTS

Rubber endless timing belts

XLDD	
Code	Pitch length (mm)
DD 120 XL	304,80
DD 130 XL	330,20
DD 140 XL	355,60
DD 146 XL	370,84
DD 150 XL	381,00
DD 156 XL	396,24
DD 160 XL	406,40
DD 170 XL	431,80
DD 176 XL	447,04
DD 180 XL	457,20
DD 182 XL	462,28
DD 188 XL	477,52
DD 190 XL	482,60
DD 198 XL	502,92
DD 200 XL	508,00
DD 202 XL	513,08
DD 210 XL	533,40
DD 212 XL	538,48
DD 214 XL	543,56
DD 220 XL	558,80
DD 228 XL	579,12
DD 230 XL	584,20
DD 234 XL	594,36
DD 240 XL	609,60
DD 250 XL	635,00
DD 260 XL	660,40
DD 270 XL	685,80
DD 276 XL	701,04
DD 290 XL	736,60
DD 310 XL	787,40
DD 316 XL	802,64
DD 320 XL	812,80
DD 330 XL	838,20
DD 344 XL	873,76
DD 352 XL	894,08
DD 364 XL	924,56
DD 380 XL	965,20
DD 384 XL	975,36
DD 388 XL	985,52
DD 390 XL	990,60
DD 392 XL	995,68
DD 434 XL	1102,36
DD 460 XL	1168,40
DD 530 XL	1346,20
DD 600 XL	1524,00
DD 710 XL	1803,40

P	5,08
H ₁	1,27
H	3,05

LDD	
Code	Pitch length (mm)
DD 124 L	314,96
DD 135 L	342,90
DD 150 L	381,00
DD 173 L	439,42
DD 187 L	474,98
DD 202 L	513,08
DD 210 L	533,40
DD 225 L	571,50
DD 240 L	609,60
DD 255 L	647,70
DD 270 L	685,80
DD 285 L	723,90
DD 300 L	762,00
DD 322 L	817,88
DD 334 L	848,36
DD 345 L	876,30
DD 367 L	932,18
DD 390 L	990,60
DD 405 L	1028,70
DD 412 L	1046,48
DD 420 L	1066,80
DD 450 L	1143,00
DD 480 L	1219,20
DD 510 L	1295,40
DD 540 L	1371,60
DD 600 L	1524,00
DD 728 L	1849,12
DD 817 L	2075,18

P	9,525
H ₁	1,91
H	4,6

HDD	
Code	Pitch length (mm)
DD 240 H	609,60
DD 270 H	685,80
DD 300 H	762,00
DD 330 H	838,20
DD 360 H	914,40
DD 390 H	990,60
DD 420 H	1066,80
DD 450 H	1143,00
DD 480 H	1219,20
DD 510 H	1295,40
DD 540 H	1371,60
DD 570 H	1447,80
DD 600 H	1524,00
DD 630 H	1600,20
DD 660 H	1676,40
DD 670 H	1701,80
DD 700 H	1778,00
DD 725 H	1841,50
DD 750 H	1905,00
DD 800 H	2032,00
DD 850 H	2159,00
DD 900 H	2286,00
DD 1000 H	2540,00
DD 1100 H	2794,00
DD 1120 H	2844,80
DD 1140 H	2895,60
DD 1150 H	2921,00
DD 1250 H	3175,00
DD 1400 H	3556,00
DD 1645 H	4178,30
DD 1700 H	4318,00

P	12,7
H ₁	2,29
H	5,9

RPP5 DD	
Code	Pitch length (mm)
600 RPP5 DD	600
610 RPP5 DD	610
615 RPP5 DD	615
635 RPP5 DD	635
640 RPP5 DD	640
670 RPP5 DD	670
675 RPP5 DD	675
700 RPP5 DD	700
705 RPP5 DD	705
710 RPP5 DD	710
725 RPP5 DD	725
740 RPP5 DD	740
750 RPP5 DD	750
755 RPP5 DD	755
800 RPP5 DD	800
835 RPP5 DD	835
850 RPP5 DD	850
890 RPP5 DD	890
900 RPP5 DD	900
935 RPP5 DD	935
940 RPP5 DD	940
950 RPP5 DD	950
980 RPP5 DD	980
1000 RPP5 DD	1000
1025 RPP5 DD	1025
1050 RPP5 DD	1050
1100 RPP5 DD	1100
1125 RPP5 DD	1125
1135 RPP5 DD	1135
1195 RPP5 DD	1195
1200 RPP5 DD	1200
1240 RPP5 DD	1240
1270 RPP5 DD	1270
1420 RPP5 DD	1420
1500 RPP5 DD	1500
1595 RPP5 DD	1595
1605 RPP5 DD	1605
1690 RPP5 DD	1690
1790 RPP5 DD	1790
1800 RPP5 DD	1800
1870 RPP5 DD	1870
1895 RPP5 DD	1895
1945 RPP5 DD	1945
2000 RPP5 DD	2000
2250 RPP5 DD	2250
2525 RPP5 DD	2525

P	5
H ₁	2
H	5,2

RPP8 DD	
Code	Pitch length (mm)
600 RPP8 DD	600
608 RPP8 DD	608
632 RPP8 DD	632
640 RPP8 DD	640
680 RPP8 DD	680
720 RPP8 DD	720
800 RPP8 DD	800
840 RPP8 DD	840
880 RPP8 DD	880
896 RPP8 DD	896
920 RPP8 DD	920
960 RPP8 DD	960
1000 RPP8 DD	1000
1040 RPP8 DD	1040
1080 RPP8 DD	1080
1120 RPP8 DD	1120
1200 RPP8 DD	1200
1224 RPP8 DD	1224
1280 RPP8 DD	1280
1352 RPP8 DD	1352
1424 RPP8 DD	1424
1440 RPP8 DD	1440
1464 RPP8 DD	1464
1600 RPP8 DD	1600
1680 RPP8 DD	1680
1760 RPP8 DD	1760
1800 RPP8 DD	1800
2000 RPP8 DD	2000
2200 RPP8 DD	2200
2272 RPP8 DD	2272
2400 RPP8 DD	2400
2520 RPP8 DD	2520
2600 RPP8 DD	2600
2800 RPP8 DD	2800
3048 RPP8 DD	3048
3280 RPP8 DD	3280
3600 RPP8 DD	3600
4400 RPP8 DD	4400

P	8
H ₁	3,2
H	7,8

RPP14 DD	
Code	Pitch length (mm)
966 RPP14 DD	966
994 RPP14 DD	994
1092 RPP14 DD	1092
1106 RPP14 DD	1106
1190 RPP14 DD	1190
1260 RPP14 DD	1260
1288 RPP14 DD	1288
1344 RPP14 DD	1344
1400 RPP14 DD	1400
1442 RPP14 DD	1442
1568 RPP14 DD	1568
1610 RPP14 DD	1610
1750 RPP14 DD	1750
1764 RPP14 DD	1764
1778 RPP14 DD	1778
1848 RPP14 DD	1848
1890 RPP14 DD	1890
1904 RPP14 DD	1904
1960 RPP14 DD	1960
2100 RPP14 DD	2100
2240 RPP14 DD	2240
2310 RPP14 DD	2310
2380 RPP14 DD	2380
2450 RPP14 DD	2450
2590 RPP14 DD	2590
2660 RPP14 DD	2660
2800 RPP14 DD	2800
2968 RPP14 DD	2968
3150 RPP14 DD	3150
3360 RPP14 DD	3360
3500 RPP14 DD	3500
3850 RPP14 DD	3850
3920 RPP14 DD	3920
4326 RPP14 DD	4326
4578 RPP14 DD	4578
4956 RPP14 DD	4956

P	14
H ₁	6
H	13,7



OPEN-END RUBBER SYNCHRONOUS BELTS



OPEN-END RUBBER SYNCHRONOUS BELTS



OPEN-END RUBBER SYNCHRONOUS BELTS

Specially suitable for linear drives, accurate positioning and reversal drives.

A high load capacity, no maintenance cost and very low noise level, make this belt a perfect alternative to chain or cable reverse drives.

Megadyne Open-end rubber belts, produced both in straight and spiral cut, are available in the following profiles, pitches and constructions:

- ISORAN®: MXL; XL; L; H
- ISORAN® RPP: RPP3; RPP5; RPP8
- ISORAN® RPP SILVER: SLV5; SLV8
- STD: STD8

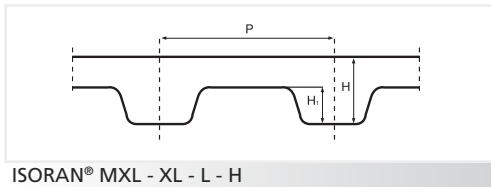

	MXL	XL	L	H
	Std. width (inches)	Std. width (inches)	Std. width (inches)	Std. width (inches)
	0,25 0,31 0,37	0,25 0,31 0,37	0,50 0,75 1,00	0,50 0,75 1,00 1,50 2,00 3,00
P	2,032	5,08	9,525	12,7
H	1,14	2,4	3,6	4,4
H1	0,51	1,27	1,91	2,29

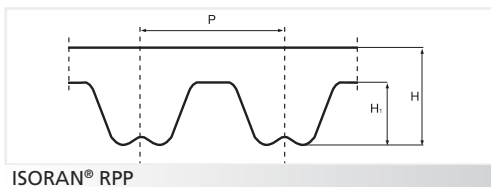

	RPP3	RPP5	RPP8
	Std. width (mm)	Std. width (mm)	Std. width (mm)
	9 12 15	9 12 15 20 25 30	10 15 20 25 30 50 85
P	3	5	8
H	2,4	3,8	5,4
H1	1,15	2	3,2

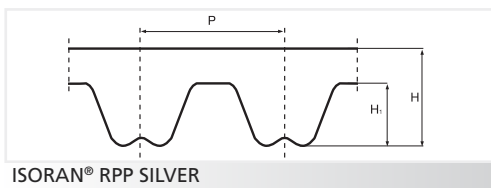

	SLV5	SLV8	STD8 M
	Std. width (mm)	Std. width (mm)	Std. width (mm)
	15 25 30	10 15 20 30 50 85	10 20 30 50 85
P	5	8	8
H	3,8	5,4	5,3
H1	2	3,2	3,05

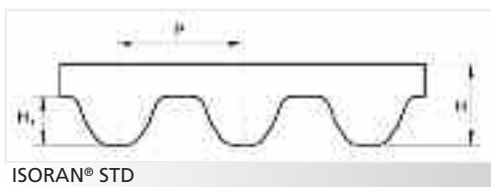

V-BELTS Rubber V-belts



OLEOSTATIC®
Classical V-belts



SP
Wedge belts



KOMPATTEX®
Wedge belts



ESAFLEX®
Double V-belts



XDV2
Xtra Duty V-belts



LINEA-X
Cogged Raw-Edge

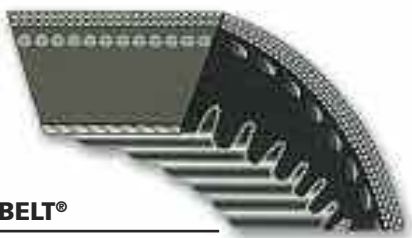

GOLD LABEL COG-BELT®
Raw-Edge V-belts



KOMPATTEX® COG BELT®
Wedge cog belts



VARISECT
Variable speed belts



PLURIBAND®
Bended V-belts

V-BELTS Rubber V-belts



V-BELTS are manufactured in polybutadiene compound. High variety of belt sizes available permits the application of Megadyne V-belts on all types of industrial equipments. Applied technology allows to reach so good dimensional precision in V-BELTS to make them suitable for multiple transmissions. This dimensional stability continues also during belt use.

V-BELTS offers the following features:

MECHANICAL features

- Smooth starting and running
- Wide range of driven speeds, using standard electric motors
- Low maintenance
- High efficient
- No need for lubrication
- Extremely wide horsepower ranges
- Dampen vibration between driver and driven pulleys
- Silent operations
- Long service life
- Easy installation
- Reduction in drive dimension

CHEMICAL features

- Working temperature range $-30\text{ }^{\circ}\text{C}$ to $+70\text{ }^{\circ}\text{C}$
- Resistance to oil and heat
- Antistatic properties

Special construction are available on request.



XDV2 BELTS

The XDV2 belts has been created for drives with small pulley diameters and high temperature peaks, combined with a high grade of moisture and humidity.

It withstands the harshest environmental requirements, such as oil and grease contaminated drives of transmissions were grits may interfere between pulleys and belt.

Thanks to its characteristics, the XDV2 perfectly matches the requirements of clutching drives as the aramid cord protect the belt against shock loads while maintaining its length constant.



V-BELTS Rubber V-belts

OLEOSTATIC

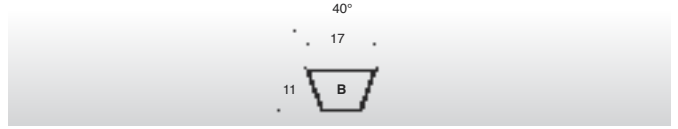
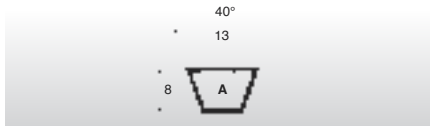
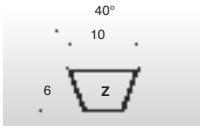

SECTION Z	
Code	Internal length (mm)
Z 16*	410
Z 17 1/4*	440
Z 18	460
Z 19	480
Z 19 1/2	500
Z 20	508
Z 20 1/2	520
Z 21 1/4*	540
Z 21 1/2	545
Z 21 3/4	555
Z 22	560
Z 22 1/4	565
Z 22 1/2	575
Z 23	585
Z 23 1/2	600
Z 23 3/4	605
Z 24	610
Z 24 3/4	630
Z 25	635
Z 25 1/2	650
Z 26	660
Z 26 1/2	670
Z 27	685
Z 27 1/2	700
Z 28	710
Z 28 1/2	725
Z 29	735
Z 29 1/2	750
Z 30	765
Z 30 1/2	775
Z 30 3/4	785
Z 31	787
Z 31 1/2	800
Z 32	815
Z 32 1/2	825
Z 33	840
Z 33 1/2	850
Z 34	865
Z 34 1/4	870
Z 34 1/2	875
Z 35	890
Z 35 1/2	900
Z 36	915
Z 36 1/2	925
Z 36 3/4	935
Z 37	945
Z 37 1/2	950
Z 38	965
Z 38 1/4	975
Z 39	1000
Z 40	1016
Z 40 1/2	1030
Z 41	1040
Z 41 1/2	1050
Z 41 3/4	1060
Z 42	1070
Z 42 1/2	1080
Z 43	1090
Z 43 1/4	1100
Z 44	1120
Z 45	1145
Z 46	1180
Z 47	1194
Z 47 3/4	1215
Z 48	1225
Z 49	1245
Z 50	1270
Z 50 1/2	1285
Z 51	1300
Z 52	1320
Z 53	1345
Z 54	1371
Z 55	1400
Z 56	1422
Z 57	1450
Z 59	1500
Z 59 1/2	1515
Z 61	1550
Z 62	1575
Z 63	1600
Z 65	1651
Z 66	1675
Z 67	1700
Z 68 1/2	1740
Z 69	1750
Z 71	1803

SECTION A	
Code	Internal length (mm)
A 15*	382
A 18	457
A 19	480
A 20	508
A 21	535
A 21 3/4*	552
A 22	560
A 23	587
A 23 1/2	600
A 24	610
A 24 1/2	620
A 24 3/4	630
A 25	637
A 25 1/2	647
A 26	660
A 26 1/2	670
A 27	686
A 27 1/2	700
A 28	710
A 28 1/2	724
A 29	737
A 29 1/2	750
A 30	767
A 30 1/2	775
A 31	787
A 31 1/2	800
A 32	813
A 32 1/2	825
A 33	838
A 33 1/4	847
A 33 1/2	850
A 33 3/4	855
A 34	867
A 34 1/2	875
A 35	900
A 36	914
A 36 1/2	925
A 37	942
A 37 1/4	946
A 37 1/2	950
A 38	965
A 38 1/2	975
A 39	992
A 39 1/2	1000
A 40	1016
A 40 1/2	1030
A 41	1041
A 41 1/2	1050
A 41 3/4	1060
A 42	1067
A 42 1/2	1075
A 43	1100
A 43 1/2	1105
A 43 3/4	1111
A 44	1120
A 44 1/2	1132
A 45	1143
A 45 1/2	1150
A 46	1168
A 46 1/2	1180
A 47	1200
A 48	1220
A 48 1/4	1225
A 49	1250
A 50	1270
A 51	1300
A 51 1/2	1307
A 52	1320
A 52 1/2	1337
A 53	1346
A 53 1/4	1355
A 54	1372
A 55	1400
A 56	1422
A 57	1450
A 58	1475
A 59	1500
A 60	1525
A 61	1550
A 62	1575
A 63	1600
A 64	1625
A 65	1650
A 66	1676
A 67	1700

SECTION A	
Code	Internal length (mm)
A 68	1725
A 69	1750
A 70	1775
A 70 3/4	1780
A 71	1800
A 72	1825
A 73	1854
A 74	1880
A 75	1900
A 76	1930
A 77	1956
A 78	1980
A 79	2000
A 80	2032
A 81	2060
A 82	2083
A 83	2100
A 83 1/2	2120
A 84	2134
A 85	2160
A 86	2187
A 87	2212
A 88	2240
A 89	2267
A 90	2286
A 91	2311
A 92	2337
A 93	2360
A 94	2388
A 95	2413
A 96	2438
A 97	2464
A 97 1/2	2475
A 98	2500
A 100	2540
A 102	2591
A 104	2650
A 105	2667
A 107	2725
A 108	2743
A 110	2800
A 112	2845
A 113	2870
A 114	2896
A 116	2946
A 118	3000
A 120	3048
A 124	3150
A 128	3250
A 130	3302
A 132	3350
A 134	3404
A 136	3454
A 140	3550
A 144	3658
A 147	3737
A 148	3750
A 155	3937
A 158	4000
A 162	4115
A 167	4250
A 173	4394
A 177	4500
A 180	4572
A 187	4750
A 197	5000
A 210	5334
A 217	5477

SECTION B	
Code	Internal length (mm)
B 22 1/2	570
B 23	587
B 24	612
B 25	637
B 26	650
B 27	686
B 28	710
B 28 1/2	725
B 29	737
B 29 1/2	750
B 30	762
B 30 1/2	775
B 31	787
B 31 1/2	800
B 32	812
B 32 1/4	822
B 32 1/2	825
B 33	838
B 33 1/2	850
B 34	867
B 34 1/2	875
B 35	889
B 35 1/2	900
B 35 3/4	907
B 36	917
B 36 1/2	925
B 36 3/4	937
B 37	942
B 37 1/2	950
B 38	965
B 38 1/2	975
B 39	990
B 39 1/2	1000
B 40	1016
B 40 1/2	1030
B 41	1040
B 41 1/2	1050
B 41 3/4	1060
B 42	1067
B 42 1/2	1075
B 43	1090
B 43 1/2	1100
B 44	1120
B 44 1/4	1127
B 45	1142
B 46	1175
B 46 1/2	1180
B 46 3/4	1187
B 47	1200
B 47 1/4	1202
B 47 1/2	1215
B 48	1225
B 49	1250
B 50	1275
B 51	1300
B 52	1320
B 53	1350
B 53 1/2	1360
B 54	1372
B 55	1400
B 55 1/2	1412
B 56	1422
B 57	1450
B 58	1473
B 59	1500
B 60	1525
B 61	1550
B 62	1575
B 63	1600
B 64	1625
B 64 1/2	1642
B 65	1650
B 66	1676
B 66 1/2	1692
B 66 1/4	1682
B 67	1700
B 67 1/4	1712
B 68	1725
B 69	1750
B 69 1/2	1761
B 70	1775
B 71	1800
B 72	1829
B 73	1850
B 74	1880

SECTION B	
Code	Internal length (mm)
B 75	1900
B 76	1930
B 77	1950
B 78	1981
B 79	2000
B 80	2032
B 80 3/4	2050
B 81	2060
B 82	2083
B 83	2108
B 83 1/2	2120
B 84	2134
B 85	2160
B 86	2187
B 86 1/2	2200
B 87	2215
B 88	2240
B 89	2261
B 90	2286
B 91	2312
B 92	2337
B 93	2360
B 94	2388
B 95	2413
B 96	2438
B 96 1/2	2450
B 97	2465
B 97 1/2	2477
B 98	2500
B 99	2515
B 100	2540
B 101	2565
B 102	2600
B 103	2616
B 104	2650
B 105	2667
B 106	2700
B 107	2718
B 108	2750
B 110	2800
B 112	2845
B 112 1/2	2857
B 114	2900
B 115	2921
B 116	2950
B 118	3000
B 120	3048
B 124	3150
B 126	3200
B 127	3227
B 128	3250
B 130	3302
B 131	3327
B 132	3350
B 133	3378
B 134	3407
B 135	3429
B 136	3450
B 140	3550
B 144	3658
B 147	3737
B 148	3750
B 151	3850
B 152	3861
B 154	3912
B 155	3950
B 157	3987
B 158	4000
B 161	4087
B 162	4115
B 163	4142
B 165	4200
B 167	4250
B 168	4267
B 173	4394
B 175	4450
B 177	4500
B 180	4572
B 186	4727
B 187	4750
B 188	4777
B 192	4877
B 195	4953
B 197	5000
B 204	5182

SECTION B	
Code	Internal length (mm)
B 208	5300
B 210	5334
B 217	5507
B 221	5577
B 223	5632
B 224	5657
B 225	5682
B 228	5757
B 229	5782
B 237	6000
B 240	6062
B 248	6267
B 249	6287
B 253	6392
B 255	6442
B 256	6502
B 259	6542
B 265	6700
B 269	6800
B 270	6825
B 276	7000
B 285	7207
B 300	7587
B 315	7967
B 330	8347
B 345	8727
B 360	9107
B 361	9132
B 364	9207
B 366	9262
B 394	9972
B 433	10957
B 472	11957
B 512	13005
B 551	13995
B 553	14053
B 669	16992

* Raw edge construction / cogged mould

V-BELTS Rubber V-belts

OLEOSTATIC

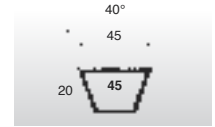
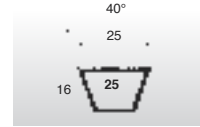
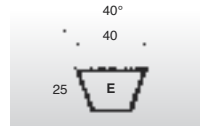
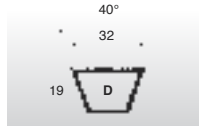
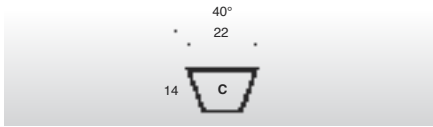

SECTION C	
Code	Internal length (mm)
C 33 3/4	858
C 37 1/2	950
C 39 3/4	1013
C 43	1090
C 45	1150
C 46	1168
C 48	1220
C 49	1250
C 51	1295
C 52	1320
C 53	1350
C 54	1372
C 55	1400
C 56	1425
C 59	1500
C 60	1524
C 61	1560
C 62 1/4	1583
C 63	1600
C 65	1650
C 67	1700
C 68	1727
C 70	1778
C 71	1798
C 75	1900
C 78	1978
C 80	2032
C 81	2057
C 83	2108
C 84	2134
C 85	2159
C 86	2184
C 87	2208
C 88	2235
C 89	2261
C 90	2286
C 93	2360
C 94	2388
C 95	2413
C 96	2438
C 97	2462
C 97 1/2	2477
C 98	2500
C 99	2525
C 100	2540
C 101	2560
C 102	2591
C 104	2642
C 105	2667
C 106	2692
C 108	2750
C 110	2800
C 111	2818
C 112	2845
C 112 1/2	2858
C 114	2888
C 115	2921
C 116	2950
C 117	2965
C 118	3000
C 120	3048
C 124	3150
C 126	3200
C 128	3250
C 130	3302
C 132	3350
C 134	3404
C 136	3456
C 138	3498
C 140	3550
C 142	3607
C 144	3658
C 147	3733
C 148	3750
C 150	3808
C 153	3902
C 158	4000
C 160	4064
C 161 1/2	4100
C 162	4115
C 165	4193
C 166	4216
C 168	4267
C 173	4394
C 177	4500

SECTION C	
Code	Internal length (mm)
C 180	4572
C 187	4750
C 195	4953
C 197	5000
C 204	5182
C 208	5300
C 210	5334
C 216	5486
C 220	5550
C 222	5600
C 225	5678
C 228	5753
C 236	6000
C 238	6045
C 240	6062
C 248	6263
C 250	6300
C 255	6438
C 265	6700
C 270	6822
C 276	6973
C 280	7100
C 285	7203
C 297	7500
C 300	7582
C 303	7650
C 314	7976
C 316	8000
C 330	8382
C 336	8500
C 345	8723
C 360	9107
C 394	10000
C 420	10632
C 424	10733

SECTION D	
Code	Internal length (mm)
D 98	2500
D 104	2650
D 110	2800
D 118	3000
D 120	3048
D 124	3150
D 128	3251
D 136	3454
D 137	3475
D 140	3550
D 144	3658
D 154	3914
D 158	4013
D 162	4115
D 170	4310
D 173	4394
D 177	4500
D 180	4572
D 187	4750
D 195	4953
D 197	5000
D 204	5182
D 205	5209
D 207	5259
D 210	5334
D 223	5600
D 225	5659
D 236	5940
D 238	6000
D 240	6039
D 248	6244
D 250	6294
D 255	6424
D 266	6700
D 270	6804
D 282	7100
D 285	7184
D 298	7500
D 300	7565
D 314	7924
D 316	7974
D 326	8224
D 330	8329
D 345	8709
D 360	9090
D 390	9849
D 394	10000
D 420	10624
D 441	11200
D 480	12139
D 510	12897
D 540	13659
D 600	15184

SECTION E	
Code	Internal length (mm)
E 180	4575
E 197	5000
E 210	5335
E 220	5600
E 226	5660
E 240	6015
E 248	6220
E 255	6400
E 270	6780
E 280	7100
E 285	7160
E 295	7500
E 300	7540
E 316	7950
E 330	8305
E 345	8685
E 354	9000
E 360	9065
E 394	9930
E 420	10600
E 441	11200
E 480	12115
E 492	12500
E 540	13635
E 600	15160

SECTION 25	
Code	Internal length (mm)
25	1800
25	1900
25	1950
25	2000
25	2050
25	2120
25	2200
25	2240
25	2325
25	2360
25	2450
25	2500
25	2650
25	2700
25	2800
25	2950
25	3000
25	3150
25	3300
25	3350
25	3550
25	3750
25	3950
25	4000
25	4250
25	4450
25	4500
25	4750
25	5000
25	5300
25	5600
25	5700
25	6000
25	6300
25	6500
25	6700
25	7100
25	7500
25	8000
25	8500
25	9000
25	9500
25	10000

SECTION 45	
Code	Internal length (mm)
45	2000
45	2300
45	2500
45	2650
45	2750
45	2850
45	3000
45	3150
45	3250
45	3300
45	3500
45	3750
45	4000

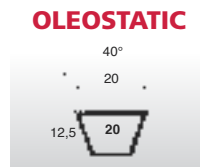

SECTION 20	
Code	Internal length (mm)
20	1800
20	1875
20	1900
20	1925
20	1950
20	2000
20	2050
20	2120
20	2200
20	2240
20	2360
20	2500
20	2600
20	2650
20	2800
20	3000
20	3150
20	3250
20	3350
20	3450
20	3550
20	3650
20	3750
20	4000
20	4250
20	4500
20	4750
20	5000
20	5300
20	5600
20	6000

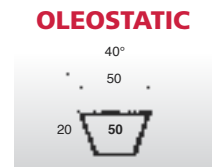

SECTION 50	
Code	Internal length (mm)
50	2000
50	2050
50	2150
50	2300
50	2500
50	2650
50	2750
50	2850
50	2870
50	3000
50	3150
50	3250
50	3300
50	3500
50	3670
50	3750
50	3950
50	4000

V-BELTS Rubber V-belts

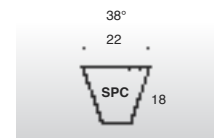
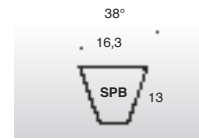
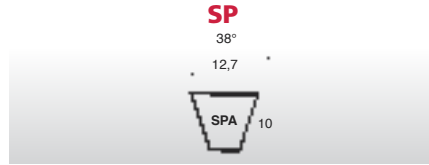
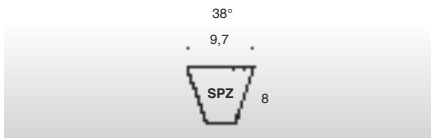

SECTION SPZ	
Code	External length (mm)
SPZ 587	600
SPZ 607	620
SPZ 612	625
SPZ 630	643
SPZ 637	650
SPZ 662	675
SPZ 670	683
SPZ 687	700
SPZ 710	723
SPZ 722	735
SPZ 737	750
SPZ 750	763
SPZ 762	775
SPZ 772	785
SPZ 787	800
SPZ 800	813
SPZ 812	825
SPZ 825	838
SPZ 837	850
SPZ 850	863
SPZ 862	875
SPZ 875	888
SPZ 887	900
SPZ 900	913
SPZ 912	925
SPZ 922	935
SPZ 925	938
SPZ 937	950
SPZ 950	963
SPZ 962	975
SPZ 975	988
SPZ 987	1000
SPZ 1000	1013
SPZ 1010	1023
SPZ 1012	1025
SPZ 1024	1037
SPZ 1037	1050
SPZ 1047	1060
SPZ 1060	1073
SPZ 1077	1090
SPZ 1087	1100
SPZ 1112	1125
SPZ 1120	1133
SPZ 1137	1150
SPZ 1140	1153
SPZ 1147	1160
SPZ 1150	1163
SPZ 1162	1175
SPZ 1180	1193
SPZ 1187	1200
SPZ 1200	1213
SPZ 1202	1215
SPZ 1212	1225
SPZ 1237	1250
SPZ 1250	1263
SPZ 1262	1275
SPZ 1270	1283
SPZ 1287	1300
SPZ 1312	1325
SPZ 1320	1333
SPZ 1337	1350
SPZ 1340	1353
SPZ 1347	1360
SPZ 1362	1375
SPZ 1387	1400
SPZ 1400	1413
SPZ 1412	1425
SPZ 1420	1433
SPZ 1437	1450
SPZ 1462	1475
SPZ 1470	1483
SPZ 1487	1500
SPZ 1500	1513
SPZ 1512	1525
SPZ 1520	1533
SPZ 1537	1550
SPZ 1562	1575
SPZ 1587	1600
SPZ 1600	1613
SPZ 1612	1625
SPZ 1637	1650
SPZ 1650	1663
SPZ 1662	1675
SPZ 1687	1700
SPZ 1700	1713

SECTION SPZ	
Code	External length (mm)
SPZ 1737	1750
SPZ 1750	1763
SPZ 1762	1775
SPZ 1787	1800
SPZ 1800	1813
SPZ 1812	1825
SPZ 1837	1850
SPZ 1850	1863
SPZ 1862	1875
SPZ 1887	1900
SPZ 1900	1913
SPZ 1937	1950
SPZ 1962	1975
SPZ 1987	2000
SPZ 2000	2013
SPZ 2019	2032
SPZ 2030	2043
SPZ 2037	2050
SPZ 2062	2075
SPZ 2087	2100
SPZ 2120	2133
SPZ 2137	2150
SPZ 2160	2173
SPZ 2187	2200
SPZ 2240	2253
SPZ 2262	2275
SPZ 2287	2300
SPZ 2360	2373
SPZ 2410	2423
SPZ 2437	2450
SPZ 2487	2500
SPZ 2500	2513
SPZ 2540	2553
SPZ 2650	2663
SPZ 2800	2813
SPZ 3000	3013
SPZ 3150	3163
SPZ 3350	3363
SPZ 3550	3563

SECTION SPA	
Code	External length (mm)
SPA 657	675
SPA 707	725
SPA 732	750
SPA 757	775
SPA 782	800
SPA 800	818
SPA 807	825
SPA 832	850
SPA 850	868
SPA 857	875
SPA 882	900
SPA 900	918
SPA 907	925
SPA 925	943
SPA 932	950
SPA 950	968
SPA 957	975
SPA 967	985
SPA 982	1000
SPA 1000	1018
SPA 1007	1025
SPA 1032	1050
SPA 1060	1078
SPA 1082	1100
SPA 1107	1125
SPA 1120	1138
SPA 1132	1150
SPA 1150	1168
SPA 1157	1175
SPA 1180	1198
SPA 1207	1225
SPA 1232	1250
SPA 1250	1268
SPA 1257	1275
SPA 1272	1290
SPA 1282	1300
SPA 1307	1325
SPA 1320	1338
SPA 1332	1350
SPA 1357	1375
SPA 1382	1400
SPA 1400	1418
SPA 1407	1425
SPA 1425	1443
SPA 1432	1450
SPA 1450	1468
SPA 1457	1475
SPA 1482	1500
SPA 1500	1518
SPA 1507	1525
SPA 1532	1550
SPA 1550	1568
SPA 1557	1575
SPA 1582	1600
SPA 1600	1618
SPA 1607	1625
SPA 1632	1650
SPA 1657	1675
SPA 1682	1700
SPA 1700	1718
SPA 1707	1725
SPA 1732	1750
SPA 1750	1768
SPA 1757	1775
SPA 1782	1800
SPA 1800	1818
SPA 1807	1825
SPA 1832	1850
SPA 1857	1875
SPA 1882	1900
SPA 1900	1918
SPA 1907	1925
SPA 1925	1943
SPA 1932	1950
SPA 1950	1968
SPA 1957	1975
SPA 1982	2000
SPA 2000	2018
SPA 2032	2050
SPA 2057	2075
SPA 2082	2100
SPA 2120	2138
SPA 2132	2150
SPA 2182	2200
SPA 2207	2225

SECTION SPA	
Code	External length (mm)
SPA 2232	2250
SPA 2240	2258
SPA 2282	2300
SPA 2300	2318
SPA 2307	2325
SPA 2332	2350
SPA 2360	2378
SPA 2382	2400
SPA 2432	2450
SPA 2482	2500
SPA 2500	2518
SPA 2532	2550
SPA 2582	2600
SPA 2607	2625
SPA 2632	2650
SPA 2650	2668
SPA 2682	2700
SPA 2732	2750
SPA 2782	2800
SPA 2800	2818
SPA 2832	2850
SPA 2847	2865
SPA 2882	2900
SPA 2900	2918
SPA 2932	2950
SPA 2982	3000
SPA 3000	3018
SPA 3032	3050
SPA 3082	3100
SPA 3150	3168
SPA 3182	3200
SPA 3250	3268
SPA 3282	3300
SPA 3350	3368
SPA 3382	3400
SPA 3550	3568
SPA 3650	3668
SPA 3750	3768
SPA 4000	4018
SPA 4250	4268
SPA 4500	4518
SPA 4750	4768

SECTION SPB	
Code	External length (mm)
SPB 1250	1272
SPB 1320	1342
SPB 1400	1422
SPB 1410	1432
SPB 1450	1472
SPB 1500	1522
SPB 1600	1622
SPB 1650	1672
SPB 1700	1722
SPB 1750	1772
SPB 1800	1822
SPB 1850	1872
SPB 1860	1882
SPB 1900	1922
SPB 1950	1972
SPB 2000	2022
SPB 2020	2042
SPB 2060	2082
SPB 2098	2120
SPB 2120	2142
SPB 2150	2172
SPB 2180	2202
SPB 2240	2262
SPB 2264	2286
SPB 2280	2302
SPB 2300	2322
SPB 2360	2382
SPB 2391	2413
SPB 2410	2432
SPB 2430	2452
SPB 2500	2522
SPB 2530	2532
SPB 2580	2602
SPB 2600	2622
SPB 2650	2672
SPB 2680	2702
SPB 2720	2742
SPB 2800	2822
SPB 2840	2862
SPB 2850	2872
SPB 2900	2922
SPB 2950	2972
SPB 3000	3022
SPB 3070	3092
SPB 3150	3172
SPB 3170	3192
SPB 3250	3272
SPB 3320	3342
SPB 3350	3372
SPB 3450	3472
SPB 3550	3572
SPB 3650	3672
SPB 3750	3772
SPB 4000	4022
SPB 4250	4272
SPB 4500	4522
SPB 4750	4772
SPB 5000	5022
SPB 5300	5322
SPB 5600	5622
SPB 6000	6022
SPB 6300	6322
SPB 6700	6722
SPB 7100	7122
SPB 7500	7522
SPB 8000	8022

SECTION SPC	
Code	External length (mm)
SPC 2000	2030
SPC 2120	2150
SPC 2240	2270
SPC 2360	2390
SPC 2500	2530
SPC 2650	2680
SPC 2800	2830
SPC 3000	3030
SPC 3150	3180
SPC 3350	3380
SPC 3550	3580
SPC 3750	3780
SPC 4000	4030
SPC 4250	4280
SPC 4500	4530
SPC 4750	4780
SPC 5000	5030
SPC 5300	5330
SPC 5600	5630
SPC 6000	6030
SPC 6300	6330
SPC 6700	6730
SPC 7100	7130
SPC 7500	7530
SPC 8000	8030
SPC 8500	8530
SPC 9000	9030
SPC 9500	9530
SPC 10000	10030
SPC 10600	10630
SPC 11200	11230
SPC 11800	11830
SPC 12000	12030
SPC 12500	12530

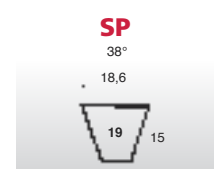

SECTION 19	
Code	Pitch length (mm)
19	1800
19	1900
19	2000
19	2120
19	2175
19	2240
19	2360
19	2500
19	2650
19	2800
19	3000
19	3150
19	3350
19	3550
19	3750
19	4000
19	4250
19	4500
19	4975
19	5000
19	6275
19	6700
19	9000
19	10000

V-BELTS Rubber V-belts

KOMPATTEX

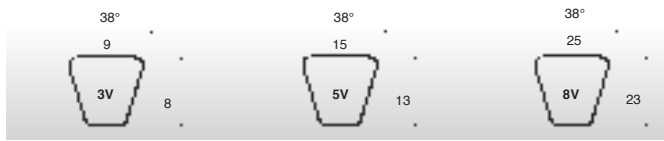

ESAFLEX

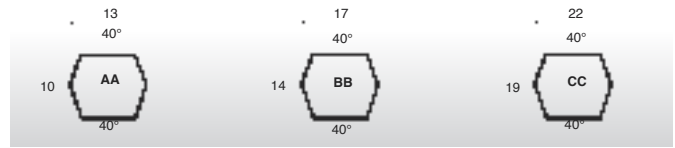

SECTION 3V

Code	External length (mm)
3V 250	635
3V 265	675
3V 280	710
3V 300	760
3V 315	800
3V 335	850
3V 355	900
3V 375	955
3V 400	1015
3V 425	1080
3V 450	1145
3V 475	1205
3V 500	1270
3V 530	1345
3V 560	1420
3V 600	1525
3V 630	1600
3V 670	1700
3V 710	1805
3V 750	1905
3V 800	2030
3V 850	2160
3V 900	2285
3V 950	2415
3V 1000	2540
3V 1060	2690
3V 1120	2845
3V 1180	2995
3V 1250	3175
3V 1320	3355
3V 1400	3555

SECTION 5V

Code	External length (mm)
5V 500	1270
5V 530	1345
5V 560	1420
5V 600	1525
5V 630	1600
5V 670	1700
5V 710	1800
5V 750	1900
5V 800	2030
5V 850	2160
5V 900	2290
5V 950	2410
5V 1000	2540
5V 1060	2690
5V 1120	2840
5V 1180	3000
5V 1250	3180
5V 1320	3350
5V 1400	3550
5V 1500	3810
5V 1600	4060
5V 1700	4320
5V 1800	4570
5V 1900	4830
5V 2000	5080
5V 2120	5380
5V 2240	5690
5V 2360	6000
5V 2500	6350
5V 2650	6730
5V 2800	7100
5V 3000	7620
5V 3150	8000
5V 3350	8500
5V 3550	9000

SECTION 8V

Code	External length (mm)
8V 1000	2540
8V 1060	2690
8V 1120	2840
8V 1180	3000
8V 1250	3180
8V 1320	3350
8V 1400	3550
8V 1500	3810
8V 1600	4060
8V 1700	4320
8V 1800	4570
8V 1900	4830
8V 2000	5080
8V 2120	5380
8V 2240	5690
8V 2360	6000
8V 2500	6350
8V 2650	6730
8V 2800	7100
8V 3000	7620
8V 3150	8000
8V 3350	8500
8V 3550	9000
8V 4000	10160
8V 4250	10800
8V 4500	11430
8V 4750	12060
8V 5000	12700

SECTION AA

Code	Effective length (mm)
AA 51	1350
AA 60	1580
AA 61	1600
AA 68	1780
AA 69	1805
AA 71	1855
AA 75	1955
AA 77	2010
AA 80	2085
AA 81	2110
AA 85	2210
AA 90	2340
AA 91	2365
AA 95	2465
AA 96	2490
AA 105	2720
AA 108	2800
AA 112	2895
AA 116	3000
AA 120	3100
AA 128	3305

SECTION BB

Code	Effective length (mm)
BB 50	1345
BB 60	1600
BB 75	1980
BB 81	2130
BB 84	2210
BB 85	2235
BB 90	2360
BB 97	2540
BB 105	2740
BB 112	2920
BB 118	3070
BB 120	3125
BB 121	3150
BB 128	3325
BB 144	3735
BB 154	4000
BB 155	4010
BB 158	4090
BB 173	4470
BB 174	4495
BB 180	4645
BB 184	4750
BB 190	4900
BB 195	5030
BB 210	5410
BB 240	6135
BB 270	6895
BB 300	7655

SECTION CC

Code	Effective length (mm)
CC 75	2015
CC 81	2165
CC 85	2265
CC 86	2290
CC 90	2395
CC 96	2545
CC 105	2775
CC 112	2955
CC 120	3155
CC 128	3360
CC 144	3765
CC 153	4000
CC 158	4120
CC 162	4225
CC 173	4500
CC 180	4680
CC 193	5000
CC 195	5060
CC 210	5440
CC 234	6000
CC 240	6155
CC 270	6915
CC 300	7675
CC 313	8000
CC 330	8440
CC 360	9200
CC 390	9965
CC 420	10725

V-BELTS Rubber V-belts

XDV2

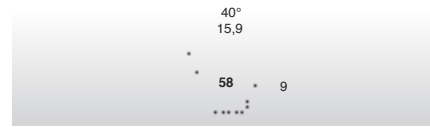
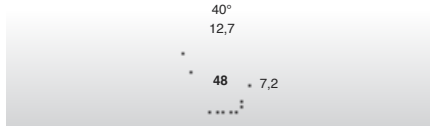
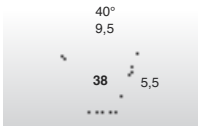

SECTION XDV2-38

Code	External length (mm)
XDV 38/150	381
XDV 38/160	406
XDV 38/170	432
XDV 38/180	457
XDV 38/190	483
XDV 38/200	508
XDV 38/210	533
XDV 38/220	559
XDV 38/230	584
XDV 38/240	610
XDV 38/250	635
XDV 38/260	660
XDV 38/270	686
XDV 38/280	711
XDV 38/290	737
XDV 38/300	762
XDV 38/310	787
XDV 38/320	813
XDV 38/330	838
XDV 38/340	864
XDV 38/350	889
XDV 38/360	914
XDV 38/370	940
XDV 38/380	965
XDV 38/390	991
XDV 38/400	1016
XDV 38/410	1041
XDV 38/420	1067
XDV 38/430	1092
XDV 38/440	1118
XDV 38/450	1143
XDV 38/460	1168
XDV 38/470	1194
XDV 38/480	1219
XDV 38/490	1245
XDV 38/500	1270
XDV 38/510	1295
XDV 38/520	1321
XDV 38/530	1346
XDV 38/540	1372
XDV 38/550	1397
XDV 38/560	1422
XDV 38/570	1448
XDV 38/580	1473
XDV 38/590	1499
XDV 38/600	1524
XDV 38/610	1549
XDV 38/620	1575
XDV 38/630	1600
XDV 38/690	1753
XDV 38/710	1803
XDV 38/740	1880
XDV 38/750	1905

SECTION XDV2-48

Code	External length (mm)
XDV 48/170	432
XDV 48/180	457
XDV 48/190	483
XDV 48/200	508
XDV 48/210	533
XDV 48/220	559
XDV 48/230	584
XDV 48/240	610
XDV 48/250	635
XDV 48/260	660
XDV 48/270	686
XDV 48/280	711
XDV 48/290	737
XDV 48/300	762
XDV 48/310	787
XDV 48/320	813
XDV 48/330	838
XDV 48/340	864
XDV 48/350	889
XDV 48/360	914
XDV 48/370	940
XDV 48/380	965
XDV 48/390	991
XDV 48/400	1016
XDV 48/410	1041
XDV 48/420	1067
XDV 48/430	1092
XDV 48/440	1118
XDV 48/450	1143
XDV 48/460	1168
XDV 48/470	1194
XDV 48/480	1219
XDV 48/490	1245
XDV 48/500	1270
XDV 48/510	1295
XDV 48/520	1321
XDV 48/530	1346
XDV 48/540	1372
XDV 48/550	1397
XDV 48/560	1422
XDV 48/570	1448
XDV 48/580	1473
XDV 48/590	1499
XDV 48/600	1524
XDV 48/610	1549
XDV 48/620	1575
XDV 48/630	1600
XDV 48/640	1626
XDV 48/650	1651
XDV 48/660	1676
XDV 48/670	1702
XDV 48/680	1727
XDV 48/690	1753
XDV 48/700	1778
XDV 48/710	1803
XDV 48/720	1829
XDV 48/730	1854
XDV 48/740	1880
XDV 48/750	1905
XDV 48/760	1930
XDV 48/770	1956
XDV 48/780	1981
XDV 48/790	2007
XDV 48/800	2032
XDV 48/810	2057
XDV 48/820	2083
XDV 48/830	2108
XDV 48/840	2134
XDV 48/850	2159
XDV 48/860	2184
XDV 48/870	2210
XDV 48/880	2235
XDV 48/890	2261
XDV 48/900	2286
XDV 48/910	2311

SECTION XDV2-48

Code	External length (mm)
XDV 48/920	2337
XDV 48/930	2362
XDV 48/940	2388
XDV 48/950	2413
XDV 48/960	2438
XDV 48/970	2464
XDV 48/980	2489
XDV 48/990	2515
XDV 48/1000	2540
XDV 48/1050	2667
XDV 48/1070	2718
XDV 48/1140	2896
XDV 48/1170	2972

SECTION XDV2-58

Code	External length (mm)
XDV 58/230	584
XDV 58/240	610
XDV 58/250	635
XDV 58/260	660
XDV 58/270	686
XDV 58/280	711
XDV 58/290	737
XDV 58/300	762
XDV 58/310	787
XDV 58/320	813
XDV 58/330	838
XDV 58/340	864
XDV 58/350	889
XDV 58/360	914
XDV 58/370	940
XDV 58/380	965
XDV 58/390	991
XDV 58/400	1016
XDV 58/410	1041
XDV 58/420	1067
XDV 58/430	1092
XDV 58/440	1118
XDV 58/450	1143
XDV 58/460	1168
XDV 58/470	1194
XDV 58/480	1219
XDV 58/490	1245
XDV 58/500	1270
XDV 58/510	1295
XDV 58/520	1321
XDV 58/530	1346
XDV 58/540	1372
XDV 58/550	1397
XDV 58/560	1422
XDV 58/570	1448
XDV 58/580	1473
XDV 58/590	1499
XDV 58/600	1524
XDV 58/610	1549
XDV 58/620	1575
XDV 58/630	1600
XDV 58/640	1626
XDV 58/650	1651
XDV 58/660	1676
XDV 58/670	1702
XDV 58/680	1727
XDV 58/690	1753
XDV 58/700	1778
XDV 58/710	1803
XDV 58/720	1829
XDV 58/730	1854
XDV 58/740	1880
XDV 58/750	1905
XDV 58/760	1930
XDV 58/770	1956
XDV 58/780	1981
XDV 58/790	2007
XDV 58/800	2032
XDV 58/810	2057
XDV 58/820	2083
XDV 58/830	2108
XDV 58/840	2134
XDV 58/850	2159
XDV 58/860	2184
XDV 58/870	2210
XDV 58/880	2235
XDV 58/890	2261
XDV 58/900	2286
XDV 58/910	2311
XDV 58/920	2337
XDV 58/930	2362
XDV 58/940	2388
XDV 58/950	2413
XDV 58/960	2438
XDV 58/970	2464

SECTION XDV2-58

Code	External length (mm)
XDV 58/980	2489
XDV 58/990	2515
XDV 58/1000	2540
XDV 58/1030	2616
XDV 58/1080	2743

V-BELTS Rubber V-belts

LINEA X

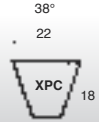
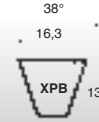
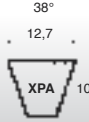

SECTION XPZ

Code	External length (mm)
XPZ 512	525
XPZ 562	575
XPZ 587	600
XPZ 612	625
XPZ 630	643
XPZ 637	650
XPZ 662	675
XPZ 670	683
XPZ 687	700
XPZ 710	723
XPZ 722	735
XPZ 737	750
XPZ 750	763
XPZ 762	775
XPZ 787	800
XPZ 800	813
XPZ 812	825
XPZ 837	850
XPZ 850	863
XPZ 862	875
XPZ 875	888
XPZ 887	900
XPZ 900	913
XPZ 912	925
XPZ 925	938
XPZ 937	950
XPZ 950	963
XPZ 962	975
XPZ 987	1000
XPZ 1000	1013
XPZ 1012	1025
XPZ 1037	1050
XPZ 1047	1060
XPZ 1060	1073
XPZ 1062	1075
XPZ 1077	1090
XPZ 1087	1100
XPZ 1112	1125
XPZ 1120	1133
XPZ 1137	1150
XPZ 1162	1175
XPZ 1180	1193
XPZ 1187	1200
XPZ 1202	1215
XPZ 1212	1225
XPZ 1237	1250
XPZ 1250	1263
XPZ 1262	1275
XPZ 1270	1283
XPZ 1287	1300
XPZ 1312	1325
XPZ 1320	1333
XPZ 1337	1350
XPZ 1362	1375
XPZ 1387	1400
XPZ 1400	1413
XPZ 1412	1425
XPZ 1420	1433
XPZ 1437	1450
XPZ 1462	1475
XPZ 1487	1500
XPZ 1500	1513
XPZ 1512	1525
XPZ 1520	1533
XPZ 1537	1550
XPZ 1587	1600
XPZ 1600	1613
XPZ 1612	1625
XPZ 1662	1675
XPZ 1700	1713
XPZ 1762	1775
XPZ 1800	1813
XPZ 1900	1913
XPZ 2000	2013
XPZ 2030	2043

SECTION XPZ

Code	External length (mm)
XPZ 2120	2133
XPZ 2160	2173
XPZ 2240	2253
XPZ 2280	2293
XPZ 2360	2373
XPZ 2410	2423
XPZ 2500	2513
XPZ 2540	2553
XPZ 2650	2663
XPZ 2690	2703
XPZ 2800	2813
XPZ 2840	2853
XPZ 3000	3013
XPZ 3150	3163
XPZ 3170	3183
XPZ 3350	3363
XPZ 3550	3563

SECTION XPA

Code	External length (mm)
XPA 667	685
XPA 682	700
XPA 732	750
XPA 757	775
XPA 782	800
XPA 800	818
XPA 807	825
XPA 832	850
XPA 850	868
XPA 857	875
XPA 882	900
XPA 900	918
XPA 907	925
XPA 932	950
XPA 950	968
XPA 957	975
XPA 969	987
XPA 982	1000
XPA 1000	1018
XPA 1007	1025
XPA 1032	1050
XPA 1057	1075
XPA 1060	1078
XPA 1082	1100
XPA 1107	1125
XPA 1120	1138
XPA 1132	1150
XPA 1150	1168
XPA 1157	1175
XPA 1180	1198
XPA 1182	1200
XPA 1207	1225
XPA 1232	1250
XPA 1250	1268
XPA 1257	1275
XPA 1272	1290
XPA 1282	1300
XPA 1307	1325
XPA 1320	1338
XPA 1332	1350
XPA 1357	1375
XPA 1382	1400
XPA 1400	1418
XPA 1407	1425
XPA 1420	1438
XPA 1432	1450
XPA 1457	1475
XPA 1482	1500
XPA 1500	1518
XPA 1507	1525
XPA 1532	1550
XPA 1557	1575
XPA 1582	1600
XPA 1600	1618
XPA 1607	1625
XPA 1632	1650
XPA 1650	1668
XPA 1682	1700
XPA 1700	1718
XPA 1732	1750
XPA 1757	1775
XPA 1782	1800
XPA 1800	1818
XPA 1832	1850
XPA 1850	1868
XPA 1900	1918
XPA 1932	1950
XPA 1957	1975
XPA 1982	2000
XPA 2000	2018
XPA 2032	2050
XPA 2057	2075
XPA 2082	2100
XPA 2120	2138
XPA 2160	2178

SECTION XPA

Code	External length (mm)
XPA 2182	2200
XPA 2240	2258
XPA 2282	2300
XPA 2300	2318
XPA 2360	2378
XPA 2432	2450
XPA 2482	2500
XPA 2500	2518
XPA 2532	2550
XPA 2582	2600
XPA 2607	2625
XPA 2632	2650
XPA 2650	2668
XPA 2682	2700
XPA 2732	2750
XPA 2782	2800
XPA 2800	2818
XPA 3000	3018
XPA 3150	3168
XPA 3350	3368
XPA 3550	3568
XPA 3750	3768
XPA 4000	4018
XPA 4250	4268
XPA 4500	4518

SECTION XPB

Code	External length (mm)
XPB 1250	1272
XPB 1260	1282
XPB 1320	1342
XPB 1340	1362
XPB 1400	1422
XPB 1410	1432
XPB 1500	1522
XPB 1510	1532
XPB 1590	1612
XPB 1600	1622
XPB 1650	1672
XPB 1690	1712
XPB 1700	1722
XPB 1800	1822
XPB 1900	1922
XPB 2000	2022
XPB 2020	2042
XPB 2120	2142
XPB 2150	2172
XPB 2240	2262
XPB 2280	2302
XPB 2360	2382
XPB 2410	2432
XPB 2500	2522
XPB 2530	2552
XPB 2650	2672
XPB 2680	2702
XPB 2800	2822
XPB 2840	2862
XPB 2900	2922
XPB 2990	3012
XPB 3000	3022
XPB 3150	3172
XPB 3170	3192
XPB 3340	3362
XPB 3350	3372
XPB 3550	3572
XPB 3750	3772
XPB 3800	3822
XPB 4000	4022
XPB 4060	4082
XPB 4250	4272
XPB 4500	4522
XPB 4750	4772
XPB 5000	5022

SECTION XPC

Code	External length (mm)
XPC 2000	2030
XPC 2120	2150
XPC 2240	2270
XPC 2360	2390
XPC 2500	2530
XPC 2650	2680
XPC 2800	2830
XPC 3000	3030
XPC 3150	3180
XPC 3350	3380
XPC 3550	3580
XPC 3750	3780
XPC 4000	4030
XPC 4250	4280
XPC 4500	4530
XPC 4750	4780
XPC 5000	5030

V-BELTS Rubber V-belts

GOLD LABEL COG-BELT®

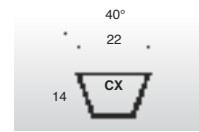
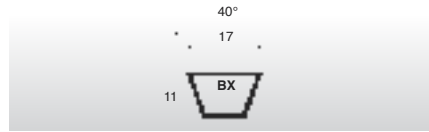
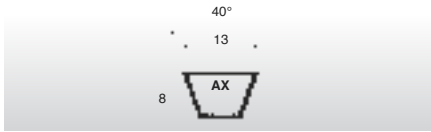

SECTION AX

Code	External length (mm)
AX 21	585
AX 22	610
AX 23	635
AX 24	665
AX 25	690
AX 26	710
AX 27	750
AX 28	765
AX 29	800
AX 30	815
AX 31	850
AX 32	865
AX 33	900
AX 34	915
AX 35	950
AX 36	965
AX 37	1000
AX 38	1020
AX 39	1045
AX 40	1075
AX 41	1095
AX 42	1120
AX 43	1150
AX 44	1170
AX 45	1195
AX 46	1230
AX 47	1245
AX 48	1270
AX 49	1300
AX 50	1325
AX 51	1350
AX 52	1375
AX 53	1400
AX 54	1425
AX 55	1450
AX 56	1475
AX 57	1500
AX 58	1525
AX 59	1550
AX 60	1585
AX 61	1600
AX 62	1630
AX 63	1655
AX 64	1680
AX 65	1710
AX 66	1730
AX 67	1760
AX 68	1790
AX 69	1810
AX 70	1830
AX 71	1865
AX 72	1890
AX 73	1905
AX 74	1935
AX 75	1965
AX 76	1985
AX 77	2010
AX 78	2030
AX 79	2060
AX 80	2080
AX 81	2120
AX 82	2140
AX 83	2160
AX 84	2190
AX 85	2220
AX 86	2240
AX 87	2260
AX 88	2290
AX 89	2310
AX 90	2350
AX 91	2360
AX 92	2390
AX 93	2420
AX 94	2440
AX 95	2470
AX 96	2500
AX 97	2520
AX 98	2540
AX 100	2600
AX 103	2670
AX 105	2730
AX 110	2850
AX 112	2910
AX 120	3110
AX 128	3310

SECTION AX

Code	External length (mm)
AX 136	3510
AX 144	3710
AX 158	4070
AX 173	4450
AX 180	4620

SECTION BX

Code	External length (mm)
BX 28	785
BX 30	835
BX 32	885
BX 34	935
BX 35	960
BX 36	990
BX 38	1040
BX 40	1090
BX 41	1120
BX 42	1140
BX 43	1165
BX 44	1190
BX 45	1215
BX 46	1250
BX 47	1265
BX 48	1295
BX 49	1320
BX 50	1345
BX 51	1370
BX 52	1400
BX 53	1420
BX 54	1445
BX 55	1470
BX 56	1500
BX 57	1520
BX 58	1545
BX 59	1570
BX 60	1600
BX 61	1625
BX 62	1650
BX 63	1675
BX 64	1700
BX 65	1725
BX 66	1750
BX 67	1775
BX 68	1800
BX 69	1825
BX 70	1850
BX 71	1875
BX 72	1900
BX 73	1930
BX 74	1955
BX 75	1980
BX 76	2000
BX 77	2030
BX 78	2050
BX 79	2080
BX 80	2110
BX 81	2130
BX 82	2160
BX 83	2180
BX 84	2210
BX 85	2240
BX 86	2260
BX 87	2280
BX 88	2310
BX 89	2330
BX 90	2360
BX 91	2390
BX 92	2410
BX 93	2440
BX 94	2460
BX 95	2500
BX 96	2510
BX 97	2540
BX 98	2560
BX 99	2590
BX 100	2620
BX 103	2690
BX 105	2740
BX 106	2770
BX 108	2820
BX 112	2920
BX 113	2940
BX 115	2990
BX 116	3020
BX 120	3130
BX 123	3200
BX 124	3220
BX 126	3270
BX 128	3330
BX 133	3450
BX 136	3530
BX 140	3630
BX 144	3740

SECTION BX

Code	External length (mm)
BX 148	3830
BX 150	3880
BX 154	3990
BX 158	4090
BX 162	4200
BX 173	4480
BX 180	4650
BX 191	4930
BX 195	5040

SECTION CX

Code	External length (mm)
CX 51	1400
CX 55	1500
CX 60	1630
CX 68	1830
CX 72	1935
CX 75	2000
CX 78	2090
CX 81	2160
CX 85	2270
CX 90	2390
CX 96	2540
CX 100	2650
CX 101	2670
CX 105	2770
CX 109	2870
CX 111	2920
CX 112	2950
CX 115	3030
CX 120	3150
CX 128	3350
CX 136	3550
CX 144	3760
CX 148	3860
CX 150	3920
CX 158	4120
CX 162	4220
CX 173	4500
CX 180	4680

V-BELTS Rubber V-belts

KOMPATTEX COG-BELT

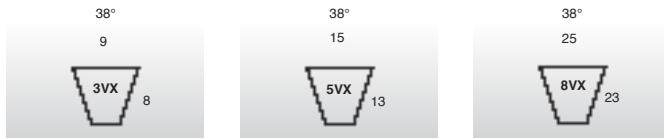

SECTION 3VX

Code	External length (mm)
3VX 250	630
3VX 265	670
3VX 280	710
3VX 300	760
3VX 315	800
3VX 335	850
3VX 355	900
3VX 375	950
3VX 400	1015
3VX 425	1080
3VX 450	1145
3VX 475	1205
3VX 500	1270
3VX 530	1345
3VX 560	1420
3VX 600	1525
3VX 630	1600
3VX 670	1700
3VX 710	1800
3VX 750	1900
3VX 800	2030
3VX 850	2160
3VX 900	2290
3VX 950	2410
3VX 1000	2540
3VX 1060	2690
3VX 1120	2840
3VX 1180	3000
3VX 1250	3180
3VX 1320	3350
3VX 1400	3550
3VX 1500	3810

SECTION 5VX

Code	External length (mm)
5VX 450	1150
5VX 470	1190
5VX 490	1250
5VX 500	1270
5VX 510	1290
5VX 530	1345
5VX 540	1370
5VX 550	1400
5VX 560	1420
5VX 570	1450
5VX 580	1470
5VX 590	1500
5VX 600	1525
5VX 610	1550
5VX 630	1600
5VX 650	1650
5VX 660	1680
5VX 670	1700
5VX 680	1730
5VX 690	1750
5VX 710	1800
5VX 730	1850
5VX 740	1880
5VX 750	1900
5VX 780	1980
5VX 800	2030
5VX 810	2060
5VX 830	2110
5VX 840	2130
5VX 850	2160
5VX 860	2180
5VX 880	2240
5VX 900	2290
5VX 930	2360
5VX 950	2410
5VX 960	2440
5VX 1000	2540
5VX 1030	2620
5VX 1060	2690
5VX 1080	2740
5VX 1120	2840
5VX 1150	2920
5VX 1160	2950
5VX 1180	3000
5VX 1230	3130
5VX 1250	3180
5VX 1320	3350
5VX 1400	3550
5VX 1500	3810
5VX 1600	4060
5VX 1700	4320
5VX 1800	4570
5VX 1900	4830
5VX 2000	5080

SECTION 8VX

Code	External length (mm)
8VX 1000	2540
8VX 1060	2690
8VX 1120	2840
8VX 1180	3000
8VX 1250	3180
8VX 1320	3350
8VX 1400	3550
8VX 1500	3810
8VX 1600	4060
8VX 1700	4320
8VX 1800	4570
8VX 1900	4830
8VX 2000	5080



V-BELTS Rubber V-belts

VARISECT

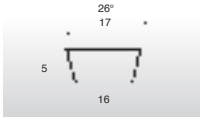

SECTION 17x5

Code	Pitch length (mm)
W 16P	450
W 16P	500
W 16P	560
W 16P	600
W 16P	630
W 16P	710
W 16P	800
W 16P	900
W 16P	1000

VARISECT

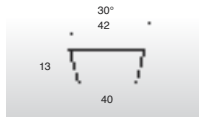

SECTION 42x13

Code	Pitch length (mm)
W 40P	1060
W 40P	1100
W 40P	1120
W 40P	1180
W 40P	1250
W 40P	1400
W 40P	1600
W 40P	1660
W 40P	1800
W 40P	2000
W 40P	2240
W 40P	2500

VARISECT

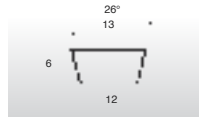

SECTION 13x6

Internal length (mm)	Pitch length (mm)
425	455
500	530
525	555
550	580
650	680
675	705
700	730
725	755
750	780
775	805
900	930

VARISECT

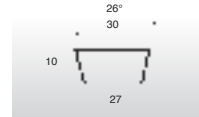

SECTION 30x10

Internal length (mm)	Pitch length (mm)
650	700
665	715
700	750
800	850
850	900
875	925
900	950
950	1000
1000	1050
1035	1085
1050	1100
1120	1170
1200	1250
1320	1370
1340	1390
1500	1550
1600	1650

VARISECT

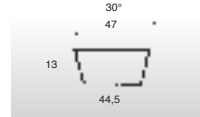

SECTION 47x13

Internal length (mm)	Pitch length (mm)
900	1000
950	1010
1000	1060
1060	1120
1120	1180
1180	1240
1250	1310
1320	1380
1400	1460
1500	1560
1600	1660
1700	1760
1800	1860
1900	1960
2000	2060
2240	2300

VARISECT

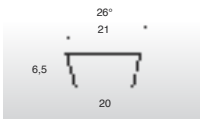

SECTION 21x6,5

Code	Pitch length (mm)
W 20P	560
W 20P	630
W 20P	640
W 20P	710
W 20P	800
W 20P	900
W 20P	1000
W 20P	1120
W 20P	1250

VARISECT

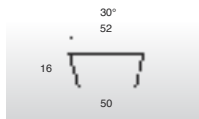

SECTION 52x16

Code	Pitch length (mm)
W 50P	1250
W 50P	1400
W 50P	1600
W 50P	1800
W 50P	2000
W 50P	2240
W 50P	2500
W 50P	2800
W 50P	3150

VARISECT

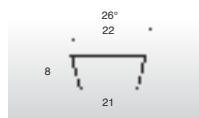

SECTION 22x8

Internal length (mm)	Pitch length (mm)
500	540
525	565
550	590
575	615
600	640
610	650
625	665
650	690
675	715
700	740
725	765
750	790
800	840
850	890
900	940
950	990
1000	1040
1060	1100
1120	1160
1180	1220
1250	1290
1320	1360
1400	1440
1500	1540
1600	1640
2000	2040

VARISECT

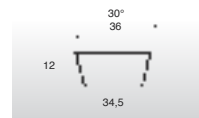

SECTION 36x12

Internal length (mm)	Pitch length (mm)
700	755
725	780
800	855
850	905
900	955
950	1005
1000	1055
1060	1115
1120	1175
1180	1235
1250	1305
1320	1375
1400	1455
1500	1555
1600	1655
1700	1755
1800	1855
2000	2055
2120	2175

VARISECT

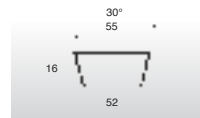

SECTION 55x16

Internal length (mm)	Pitch length (mm)
1180	1255
1250	1325
1400	1475
1600	1675
1700	1775
1800	1875
2000	2075
2240	2315

VARISECT

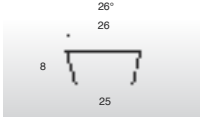

SECTION 26x8

Code	Pitch length (mm)
W 25P	560
W 25P	690
W 25P	710
W 25P	750
W 25P	790
W 25P	800
W 25P	900
W 25P	1000
W 25P	1120
W 25P	1250
W 25P	1400
W 25P	1600

VARISECT

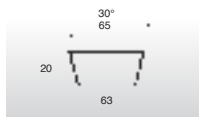

SECTION 65x20

Code	Internal length (mm)
W 63P	1600
W 63P	1800
W 63P	2000
W 63P	2240
W 63P	2500
W 63P	2800
W 63P	3150
W 63P	3550
W 63P	4000

VARISECT

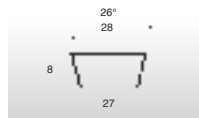

SECTION 28x8

Internal length (mm)	Pitch length (mm)
525	565
600	640
625	665
650	690
700	740
750	790
800	840
850	890
900	940
950	990
1000	1040
1060	1100
1120	1160
1180	1220
1250	1290
1320	1360
1400	1440
1500	1540
1600	1640
1700	1740

VARISECT

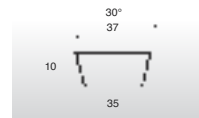

SECTION 37x10

Internal length (mm)	Pitch length (mm)
600	650
650	700
675	725
750	800
800	850
850	900
900	950
950	1000
1000	1050
1060	1110
1120	1170
1180	1230
1250	1300
1320	1370
1400	1450
1500	1550
1600	1650
1700	1750
1800	1850
1900	1950
2000	2050
2240	2290

VARISECT

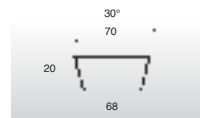

SECTION 70x20

Internal length (mm)	Pitch length (mm)
1320	1415
1400	1495
1445	1540
1500	1595
1600	1695
1700	1795
1800	1895
1900	1995
2000	2095
2120	2210
2240	2330
2360	2450
2500	2590
2800	2890

VARISECT

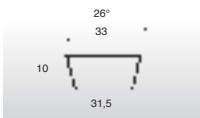

SECTION 33x10

Code	Pitch length (mm)
W 31,5P	800
W 31,5P	840
W 31,5P	870
W 31,5P	900
W 31,5P	950
W 31,5P	1000
W 31,5P	1050
W 31,5P	1120
W 31,5P	1250
W 31,5P	1400
W 31,5P	1600
W 31,5P	1800
W 31,5P	2000

V-BELTS Rubber V-belts

PLURIBAND®

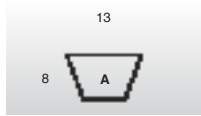

SECTION A

Code	Internal length (mm)
A 47	1200
A 51	1300
A 56	1422
A 57	1450
A 59	1500
A 64	1625
A 67	1700
A 71	1800
A 75	1900
A 79	2000
A 88	2240
A 98	2500
A 100	2540
A 104	2650
A 112	2845
A 120	3048
A 128	3250
A 144	3658
A 158	4000
A 167	4250
A 187	4750

PLURIBAND®



SECTION SPZ

Code	External length (mm)
SPZ 1250	1250
SPZ 1400	1400
SPZ 1500	1500
SPZ 1600	1600
SPZ 1700	1700
SPZ 1800	1800
SPZ 1900	1900
SPZ 2000	2000
SPZ 2120	2120
SPZ 2240	2240
SPZ 2360	2360
SPZ 2500	2500
SPZ 2650	2650
SPZ 2800	2800
SPZ 3000	3000
SPZ 3150	3150
SPZ 3350	3350
SPZ 3550	3550

PLURIBAND®



SECTION SPA

Code	Internal length (mm)
SPA 1250	1250
SPA 1400	1400
SPA 1500	1500
SPA 1600	1600
SPA 1700	1700
SPA 1800	1800
SPA 1900	1900
SPA 2000	2000
SPA 2120	2120
SPA 2240	2240
SPA 2360	2360
SPA 2500	2500
SPA 2650	2650
SPA 2800	2800
SPA 3000	3000
SPA 3150	3150
SPA 3350	3350
SPA 3550	3550
SPA 3750	3750
SPA 4000	4000
SPA 4250	4250
SPA 4500	4500

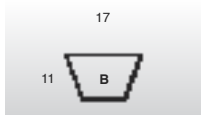

SECTION B

Code	Internal length (mm)
B 70	1778
B 71	1803
B 72	1829
B 73	1854
B 74	1880
B 75	1905
B 76	1930
B 78	1981
B 79	2007
B 80	2032
B 81	2057
B 82	2083
B 83	2108
B 84	2134
B 85	2159
B 86	2184
B 87	2210
B 88	2235
B 89	2261
B 90	2286
B 91	2311
B 92	2337
B 93	2362
B 94	2388
B 95	2413
B 96	2438
B 97	2464
B 98	2489
B 99	2515
B 100	2540
B 102	2591
B 104	2642
B 105	2667
B 106	2692
B 107	2718
B 108	2743
B 110	2794
B 112	2845
B 114	2896
B 115	2921
B 116	2946
B 118	2997
B 120	3048
B 124	3150
B 127	3226
B 128	3251
B 130	3302
B 131	3327
B 132	3353
B 133	3378
B 134	3404
B 135	3429
B 136	3454
B 140	3556
B 144	3658
B 147	3734
B 148	3759
B 151	3835
B 152	3861
B 154	3912
B 157	3988
B 158	4013
B 161	4089
B 162	4115
B 163	4140
B 165	4191
B 167	4242
B 168	4267
B 173	4394
B 175	4445
B 177	4496
B 180	4572
B 186	4724
B 188	4775
B 192	4877
B 195	4953
B 197	5004

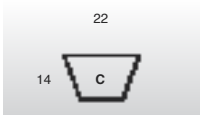

SECTION C

Code	Internal length (mm)
C 98	2489
C 99	2515
C 100	2540
C 101	2565
C 102	2591
C 104	2642
C 105	2667
C 106	2692
C 108	2743
C 110	2794
C 112	2845
C 115	2921
C 118	2997
C 120	3048
C 124	3150
C 128	3251
C 130	3302
C 134	3404
C 136	3454
C 140	3556
C 142	3607
C 144	3658
C 148	3759
C 153	3886
C 158	4013
C 160	4064
C 165	4191
C 166	4216
C 168	4267
C 173	4394
C 180	4572
C 195	4953
C 210	5334

PLURIBAND®



SECTION SPB

Code	Internal length (mm)
SPB 2000	2000
SPB 2120	2120
SPB 2240	2240
SPB 2360	2360
SPB 2500	2500
SPB 2650	2650
SPB 2800	2800
SPB 3000	3000
SPB 3150	3150
SPB 3350	3350
SPB 3550	3550
SPB 3750	3750
SPB 4000	4000
SPB 4250	4250
SPB 4500	4500
SPB 4750	4750
SPB 5000	5000
SPB 5300	5300
SPB 5600	5600
SPB 6000	6000
SPB 6300	6300
SPB 6700	6700
SPB 7100	7100
SPB 7500	7500
SPB 8000	8000

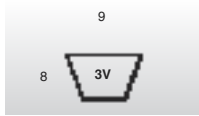

SECTION 3V

Code	External length (mm)
3V 335	850
3V 355	900
3V 375	950
3V 400	1015
3V 425	1080
3V 450	1145
3V 475	1205
3V 500	1270
3V 530	1345
3V 560	1420
3V 600	1525
3V 630	1600
3V 670	1700
3V 710	1800
3V 750	1900
3V 800	2030
3V 850	2160
3V 900	2290
3V 950	2410
3V 1000	2540
3V 1060	2690
3V 1120	2840
3V 1180	3000
3V 1250	3180
3V 1320	3350
3V 1400	3550

PLURIBAND®



SECTION SPC

Code	Internal length (mm)
SPC 3000	3000
SPC 3150	3150
SPC 3350	3350
SPC 3550	3550
SPC 3750	3750
SPC 4000	4000
SPC 4250	4250
SPC 4500	4500
SPC 4750	4750
SPC 5000	5000
SPC 5300	5300
SPC 5600	5600
SPC 6000	6000
SPC 6300	6300
SPC 6700	6700
SPC 7100	7100
SPC 7500	7500
SPC 8000	8000
SPC 8500	8500
SPC 9000	9000
SPC 9500	9500
SPC 10000	10000
SPC 10600	10600
SPC 11200	11200

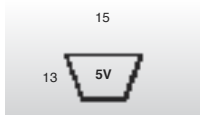

SECTION 5V

Code	External length (mm)
5V 500	1270
5V 530	1345
5V 560	1420
5V 600	1525
5V 630	1600
5V 670	1700
5V 710	1800
5V 750	1900
5V 800	2030
5V 850	2160
5V 900	2290
5V 950	2410
5V 1000	2540
5V 1120	2840
5V 1180	3000
5V 1250	3180
5V 1320	3350
5V 1400	3550
5V 1500	3810
5V 1600	4060
5V 1700	4320
5V 1800	4570
5V 1900	4830
5V 2000	5080
5V 2120	5380
5V 2240	5690
5V 2360	6000
5V 2500	6350
5V 2650	6730
5V 2800	7100
5V 3000	7620
5V 3150	8000
5V 3350	8500
5V 3550	9000

PLURIBAND®



SECTION 3VX

Code	External length (mm)
3VX 250	630
3VX 265	670
3VX 280	710
3VX 300	760
3VX 315	800
3VX 335	850
3VX 355	900
3VX 375	950
3VX 400	1015
3VX 425	1080
3VX 450	1145
3VX 475	1205
3VX 500	1270
3VX 530	1345
3VX 560	1420
3VX 600	1525
3VX 630	1600
3VX 670	1700
3VX 710	1800
3VX 750	1900
3VX 800	2030
3VX 850	2160
3VX 900	2290
3VX 950	2410
3VX 1000	2540
3VX 1060	2690
3VX 1120	2840
3VX 1180	3000
3VX 1250	3180
3VX 1320	3350
3VX 1400	3550

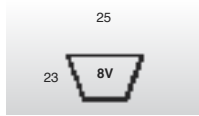

SECTION 8V

Code	External length (mm)
8V 1000	2540
8V 1060	2690
8V 1120	2840
8V 1180	3000
8V 1250	3180
8V 1320	3350
8V 1400	3550
8V 1500	3810
8V 1600	4060
8V 1700	4320
8V 1800	4570
8V 1900	4830
8V 2000	5080
8V 2120	5380
8V 2240	5690
8V 2360	6000
8V 2500	6350
8V 2650	6730
8V 2800	7100
8V 3000	7620
8V 3150	8000
8V 3350	8500
8V 3550	9000
8V 3750	9500
8V 4000	10160
8V 4250	10800
8V 4500	11430
8V 4750	12060
8V 5000	12700
8V 5600	14200
8V 6000	15250

PLURIBAND®

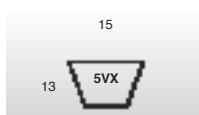

SECTION 5VX

Code	External length (mm)
5VX 500	1270
5VX 530	1345
5VX 560	1420
5VX 600	1525
5VX 630	1600
5VX 670	1700
5VX 710	1800
5VX 800	2030
5VX 850	2160
5VX 900	2290
5VX 950	2410
5VX 1000	2540
5VX 1060	2690
5VX 1120	2840
5VX 1180	3000
5VX 1250	3180
5VX 1320	3350
5VX 1400	3550
5VX 1500	3810
5VX 1600	4060
5VX 1700	4320
5VX 1800	4570
5VX 1900	4830
5VX 2000	5080

PV V-RIBBED BELTS Rubber belts



PV V-RIBBED BELTS Rubber belts



PV V-RIBBED BELTS are made of polybutadiene compound.

High performance V ribbed belts are produced in **H, J, L** and **M** profiles (K on request).

PV belts design:

- eliminates belt matching;
- permits drive design to meet exact power or space requirements;
- distributes the drive load across the entire belt width;
- permits cooler running and high drive efficiency;
- excels on small pulleys at high speeds.

PV-Ribbed belts are also available in elastic version (TEM) and they are suitable in the transmission where fixed centre distance is required. The TEM belt is developed according to the Customer requirements.

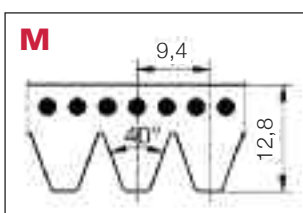
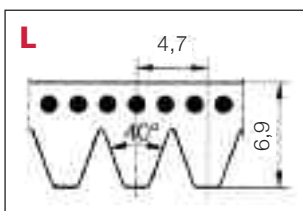
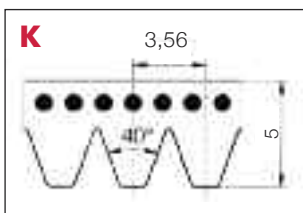
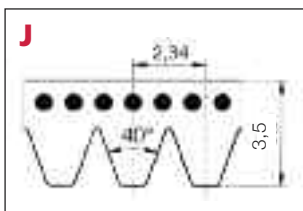
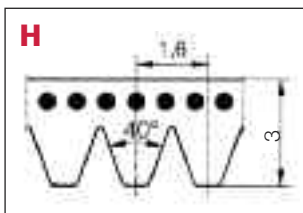

J		J		K		L		M	
Effective length		Effective length		Effective length		Effective length		Effective length	
(mm)	(inches)	(mm)	(inches)	(mm)	(inches)	(inches)	(mm)		
350	13.8	1236	48.7	630	24.8	37.5			900
381	15.0	1244	49.0	650	25.6	39.0			940
406	16.0	1262	49.7	675	26.6	42.3			990
432	17.0	1270	50.0	700	27.6	42.5			1060
457	18.0	1280	50.4	730	28.7	43.3			1115
483	19.0	1287	50.7	755	29.7	47.0			1150
495	19.5	1295	51.0	775	30.5	50.0			1185
508	20.0	1302	51.3	800	31.5	52.0			1230
533	21.0	1315	51.8	830	32.7	52.5			1310
559	22.0	1318	51.9	845	33.3	54.0			1390
584	23.0	1321	52.0	870	34.3	55.0			1470
610	24.0	1326	52.2	885	34.8	56.0			1610
650	25.6	1365	53.7	920	36.2	56.5			1650
660	26.0	1371	54.0	925	36.4	58.0			1760
685	27.0	1397	55.0	950	37.4	61.5			1830
711	28.0	1428	56.2	970	38.2	63.5			1980
723	28.5	1473	58.0	1000	39.4	65.5			2130
737	29.0	1524	60.0	1015	40.0	67.5			2410
762	30.0	1549	61.0	1035	40.8	69.5			2710
769	30.3	1651	65.0	1060	41.7	71.0			3010
790	31.1	1752	69.0	1080	42.5	72.5			3310
813	32.0	1854	73.0	1145	45.1	76.5			3610
864	34.0	1895	74.6	1165	45.9	77.0			3910
895	35.2	1910	75.2	1200	47.2	78.0			4210
914	36.0	1930	76.0	1230	48.4	79.5			4810
944	37.2	1956	77.0	1300	51.2	81.5			5410
955	37.6	2083	82.0	1335	52.6	82.5			6010
965	38.0	2135	84.1	1385	54.5	84.0			6600
990	39.0	2210	87.0	1420	55.9	86.5			
1016	40.0	2337	92.0	1460	57.5	88.0			
1036	40.8	2489	98.0	1490	58.7	91.5			
1040	40.9			1520	59.8	93.0			
1051	41.4			1555	61.2	97.5			
1065	41.9			1610	63.4	99.0			
1080	42.5			1655	65.2	106.5			
1089	42.9			1700	66.9	108.0			
1092	43.0			1725	67.9	112.0			
1100	43.3			1755	69.1	114.0			
1108	43.6			1800	70.9	115.0			
1116	43.9			1860	73.2	118.0			
1136	44.7			1885	74.2	121.5			
1143	45.0			1900	74.8	123.0			
1150	45.3			1980	78.0	129.5			
1160	45.7			2050	80.7	131.0			
1168	46.0			2080	81.9	137.5			
1170	46.1			2145	84.5	145.5			
1184	46.6			2235	88.0	159.5			
1190	46.9			2330	91.7	165.0			
1194	47.0			2490	98.03	176.0			
1200	47.2			2555	100.59	182.0			
1203	47.4					198.0			
1210	47.6					212.0			
1214	47.8					240.0			
1222	48.1								
1232	48.5								

MEGAFLAT PU and rubber endless flat belts



MEGAFLAT belts are truly endless mandrel moulded, available in both polyurethane or chloroprene rubber, with either polyester, aramide or cotton reinforcements. Standard sleeves are available 330 mm wide.

These belts have the following features:

- High flexibility
- Small pulley diameters
- Dimensional accuracy
- High speed
- Energy efficient
- Low noise and vibration
- Low maintenance
- Good chemical and ozone resistance
- High friction surface

MEGAFLAT belts are particularly suitable for both power transmission and conveying.

TENSILE REINFORCEMENT
INSTALLATION TENSION x cm WIDTH (N) ENDLESS
MIN. PULLEY DIA. mm
THICKNESS mm
STANDARD LENGTH mm
COATING MATERIAL
ANTISTATIC

T 75	T 150	T 200
Polyester fabric	Polyester fabric	Polyester fabric
150	300	400
6	15	20
0,5	0,9	1,1
200/3850	200/3850	200/3850
NEOPRENE	NEOPRENE	NEOPRENE
YES	YES	YES

TENSILE REINFORCEMENT
INSTALLATION TENSION x cm WIDTH (N) ENDLESS
MIN. PULLEY DIA. mm
THICKNESS mm
STANDARD LENGTH mm
COATING MATERIAL
ANTISTATIC

P 0	P 102	P 108	P 110
No fabric	Elastic fabric/nylon	Polyester/cotton	Polyester fabric
-	10	200	150
8	25	5	12
0,9	1,8	0,8	1
240/1200	240/2500	240/3850	240/3850
POLYURETHANE	POLYURETHANE	POLYURETHANE	POLYURETHANE
NO	POSSIBLE	POSSIBLE	POSSIBLE

TENSILE REINFORCEMENT
INSTALLATION TENSION x cm WIDTH (N) ENDLESS
MIN. PULLEY DIA. mm
THICKNESS mm
STANDARD LENGTH mm
COATING MATERIAL
ANTISTATIC

P 120	P 155	S 110
Polyester fabric	Aramid/polyester	Polyester fabric
350	400	125
20	25	12
1,5	2	1,0
240/3850	240/3850	240/3850
POLYURETHANE	POLYURETHANE	SILICON
POSSIBLE	POSSIBLE	POSSIBLE

MEGAPOWER PU endless timing belts



MEGAPOWER PU endless timing belts



MEGAPOWER timing belts are manufactured by a unique thermoset moulding process.

The high-grade polyurethane gives excellent abrasion and shear resistance, combined with a variety of graded steel cords, ensuring high strength and tractive resistance. The result is a timing belt with excellent dimensional stability. Megapower moulded timing belts are manufactured to a tight tolerance range, which assures consistent length and thickness.

The combination of these factors results in Megapower, performing to the highest physical and chemical levels.

Special compounds and cords have to be tested and homologated on the application. Megadyne is not responsible for wrong functioning of special products.

MEGAPOWER PU belts are suitable for high power, precision motion and control even with high speed.

These belts have the following features:

MECHANICAL features

- Consistent dimensional stability
- Low pre-tension
- Low noise
- High abrasion resistance
- Low maintenance
- High flexibility
- Linear speeds up to 80 m/sec

CHEMICAL features

- Good resistance to
 - Aging,
 - Hydrolysis,
 - UVA rays,
 - Ozone
- Working temperature: -25 °C to +80 °C (up to +110 °C for short periods)
- High resistance to oils, fats and greases
- Good resistance to most acids and Alkalis

MEGAPOWER PU belts perform especially well on light synchronised and stepped drives, in office automation and domestic appliance applications.



MEGAPOWER PU endless timing belts

T2 - T2.5 - T5 - T10

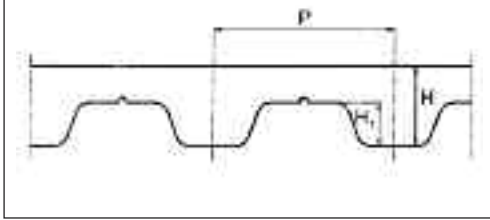

T5 - T10* available without nose

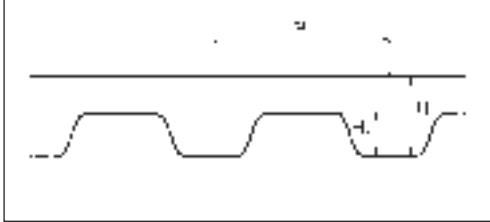

T2.5 DL - T5 DL - T10 DL

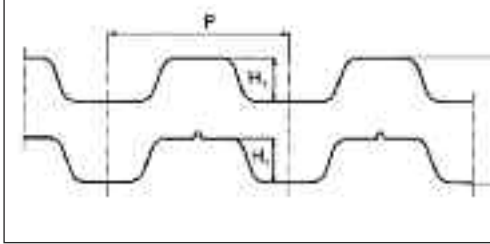

AT5 - AT10

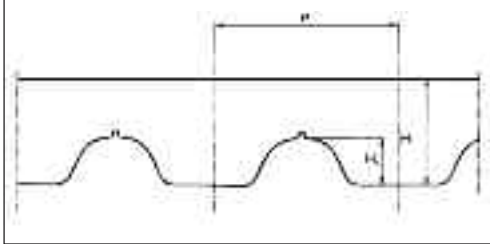

MXL - XL - L - H

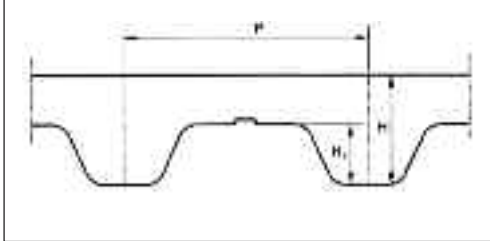

T2.5	
Std. width (mm)	
4/6/8/10/12	

T5	
Std. width (mm)	
6/8/10/12/16/20/25	

T10	
Std. width (mm)	
10/12/16/20/25/32/50/75	

T2.5 DL	
Std. width (mm)	
4/6/8/10/12	

T2.5		T5	
Code	Pitch length (mm)	Code	Pitch length (mm)
120	120	120	120
145	145	150	150
160	160	165	165
177,5	177,5	180	180
180	180	185	185
182,5	182,5	200	200
200	200	210	210
210	210	215	215
230	230	220	220
245	245	225	225
265	265	245	245
277,5	277,5	250	250
285	285	255	255
290	290	260	260
305	305	270	270
317,5	317,5	275	275
330	330	280	280
342,5	342,5	295	295
380	380	300	300
420	420	305	305
480	480	330	330
500	500	340	340
540	540	350	350
600	600	355	355
620	620	365	365
650	650	375	375
680	680	390	390
700	700	400	400
780	780	410	410
880	880	420	420
915	915	425	425
950	950	440	440
1185	1185	445	445
		450	450
		455	455
		460	460
		475	475
		480	480
		500	500
		510	510
		515	515
		515*	515*
		525	525
		545	545
		550	550
		560	560
		560*	560*
		575	575
		590	590
		600	600
		610	610
		620	620
		630	630
		640	640
		650	650
		660	660
		675	675
		690	690
		700	700
		720	720
		725	725
		750	750
		765	765
		780	780
		800	800
		815	815
		830	830
		840	840
		850	850
		860	860
		885	885
		900	900
		920	920
		940	940
		990	990
		1075	1075
		1100	1100
		1160	1160
		1200	1200
		1215	1215
		1275	1275
		1280	1280
		1315	1315
		1355	1355
		1380	1380
		1440	1440
		1470	1470
		1500	1500
		1580	1580
		1955	1955

P	2,5
H	1,3
H ₁	0,7

T2	
Std. width (mm)	
4/6/8/10/12	

T2	
Code	Pitch length (mm)
180	180
200	200
288	288

P	2
H	1,1
H ₁	0,5

T5		T10	
Code	Pitch length (mm)	Code	Pitch length (mm)
120	120	260	260
150	150	320	320
165	165	340	340
180	180	370	370
185	185	390	390
200	200	400	400
210	210	410	410
215	215	440	440
220	220	450	450
225	225	480	480
245	245	500	500
250	250	530	530
255	255	550	550
260	260	560	560
270	270	600	600
275	275	600*	600*
280	280	610	610
295	295	630	630
300	300	630*	630*
305	305	650	650
330	330	660	660
340	340	680	680
350	350	690	690
355	355	700	700
365	365	720	720
375	375	720*	720*
390	390	730	730
400	400	750	750
410	410	780	780
420	420	800*	800*
425	425	810	810
440	440	840	840
445	445	850	850
450	450	880	880
455	455	890	890
460	460	900	900
475	475	900*	900*
480	480	910	910
500	500	920	920
510	510	920*	920*
515	515	950	950
515*	515*	960	960
525	525	970	970
545	545	980	980
550	550	1000	1000
560	560	1010	1010
560*	560*	1050	1050
575	575	1080	1080
590	590	1100	1100
600	600	1110	1110
610	610	1140	1140
620	620	1150	1150
630	630	1200	1200
640	640	1210	1210
650	650	1240	1240
660	660	1250	1250
675	675	1300	1300
690	690	1320	1320
700	700	1350	1350
720	720	1390	1390
725	725	1400	1400
750	750	1420	1420
765	765	1440	1440
780	780	1440	1440
800	800	1450	1450
815	815	1460	1460
830	830	1500	1500
840	840	1550	1550
850	850	1600	1600
860	860	1610	1610
885	885	1700	1700
900	900	1750	1750
920	920	1780	1780
940	940	1880	1880
990	990	1960	1960
1075	1075	2250	2250
1100	1100		
1160	1160		
1200	1200		
1215	1215		
1275	1275		
1280	1280		
1315	1315		
1355	1355		
1380	1380		
1440	1440		
1470	1470		
1500	1500		
1580	1580		
1955	1955		

P	5
H	2,2
H ₁	1,2

T10		T2.5 DL	
Code	Pitch length (mm)	Code	Pitch length (mm)
260	260	457,5 DL	457,5
320	320		
340	340		
370	370		
390	390		
400	400		
410	410		
440	440		
450	450		
480	480		
500	500		
530	530		
550	550		
560	560		
600	600		
600*	600*		
610	610		
630	630		
630*	630*		
650	650		
660	660		
680	680		
690	690		
700	700		
720	720		
720*	720*		
730	730		
750	750		
780	780		
800*	800*		
810	810		
840	840		
850	850		
880	880		
890	890		
900	900		
900*	900*		
910	910		
920	920		
920*	920*		
950	950		
960	960		
970	970		
980	980		
1000	1000		
1010	1010		
1050	1050		
1080	1080		
1100	1100		
1110	1110		
1140	1140		
1150	1150		
1200	1200		
1210	1210		
1240	1240		
1250	1250		
1300	1300		
1320	1320		
1350	1350		
1390	1390		
1400	1400		
1420	1420		
1440	1440		
1440	1440		
1450	1450		
1460	1460		
1500	1500		
1550	1550		
1600	1600		
1610	1610		
1700	1700		
1750	1750		
1780	1780		
1880	1880		
1960	1960		
2250	2250		

P	10
H	4,5
H ₁	2,5

T2.5 DL	
Code	Pitch length (mm)
457,5 DL	457,5

P 2,5

H 1,3

H₁ 0,7

T5 DL	
Std. width (mm)	
6/8/10/12/16/20/25	

T5 DL	
Code	Pitch length (mm)
410 DL	410
460 DL	460
515 DL	515
525 DL	525
550 DL	550
590 DL	590
620 DL	620
685 DL	685
700 DL	700
750 DL	750
815 DL	815
840 DL	840
860 DL	860
940 DL	940
1100 DL	1100

P	5
H	2,2
H ₁	1,2

T10 DL	
Std. width (mm)	
10/12/16/20/25/32/50/75	

T10 DL	
Code	Pitch length (mm)
260 DL	260
530 DL	530
630 DL	630
660 DL	660
700 DL	700
720 DL	720
800 DL	800
840 DL	840
900 DL	900
920 DL	920
980 DL	980
1010 DL	1010
1100 DL	1100
1150 DL	1150
1210 DL	1210
1240 DL	1240
1250 DL	1250
1320 DL	1320
1350 DL	1350
1420 DL	1420
1610 DL	1610
1880 DL	188

MEGAPOWER PU endless timing belts

AT5		AT10		MXL		XL		L		H	
Std. width (mm)		Std. width (mm)		Std. width (mm)		Std. width (mm)		Std. width (mm)		Std. width (mm)	
6/8/10/12/16/20/25		10/12/16/20/25/32/50/75		3,2/4,8/6,4		6,4/7,9/9,4		12,7/19,1/25,4		19,1/25,4/38,1/50,8/76,2	
AT5		AT10		MXL		XL		L		H	
Code	Pitch length (mm)	Code	Pitch length (mm)	Code	Pitch length (mm)	Code	Pitch length (mm)	Code	Pitch length (mm)	Code	Pitch length (mm)
225	225	370	370	80055	111,7	60	152,4	86	218,6	230	584,2
255	255	500	500	80057	115,8	70	177,8	124	314,3	240	609,6
275	275	560	560	80060	121,9	76	193,0	150	381,0	270	685,8
280	280	580	580	80070	142,2	80	203,2	173	438,1	300	762,0
300	300	600	600	80072	146,3	90	228,6	187	476,2	330	838,2
330	330	610	610	80075	152,4	100	254,0	202	514,4	360	914,4
340	340	630	630	80076	154,4	110	269,4	210	533,4	390	990,6
375	375	660	660	80079	160,5	120	304,8	225	571,5	420	1066,8
390	390	700	700	80080	162,5	130	330,2	240	609,6	450	1143,0
420	420	730	730	80082	166,6	134	340,3	255	647,7	480	1219,2
450	450	780	780	80088	178,8	140	355,6	270	685,8	510	1295,4
455	455	800	800	80091	184,9	150	381,0	285	723,9		
480	480	810	810	80092	186,9	160	406,4	300	762,0	P	12,7
500	500	840	840	80096	195,1	170	431,8	322	817,9	H	4,3
525	525	880	880	80101	205,2	180	457,2	345	876,3	H ₁	2,29
545	545	890	890	80102	207,2	190	482,6	367	933,4		
600	600	920	920	80103	209,2	194	492,7	390	990,6		
610	610	960	960	80105	213,3	200	508,0	420	1066,8		
620	620	980	980	80110	223,5	210	533,4	450	1143,0		
630	630	1000	1000	80114	231,6	220	558,8	480	1219,2		
660	660	1010	1010	80118	239,7	230	584,2	510	1295,4		
670	670	1050	1050	80120	243,8	240	609,6	540	1371,6		
710	710	1080	1080	80130	264,1	250	635,0	570	1447,8		
720	720	1100	1100	80132	268,2	260	660,4	600	1524,0		
750	750	1150	1150	80135	274,3	270	685,8				
780	780	1190	1190	80140	284,4	288	731,5	P	9,525		
825	825	1200	1200	80145	294,6	290	736,6	H	3,6		
860	860	1210	1210	80150	304,8	300	762,0	H ₁	1,9		
975	975	1220	1220	80155	314,9	356	904,2				
1050	1050	1230	1230	80175	355,6	414	1051,5				
1125	1125	1240	1240	80190	386,5	450	1143,0				
1500	1500	1250	1250	80200	406,8	566	1437,6				
2000	2000	1280	1280	80221	449,1						
		1300	1300	80256	520,1						
P	5	1320	1320	80280	568,9						
H	2,7	1350	1350	80285	579,1						
H ₁	1,2	1360	1360	80308	625,8						
		1400	1400	80332	674,6						
		1420	1420	80352	715,2						
		1480	1480	80360	731,5						
		1500	1500	80395	802,6						
		1600	1600	80405	822,9						
		1630	1630	80412	837,1						
		1700	1700	80432	877,8						
		1720	1720	80454	922,5						
		1800	1800	80485	985,5						
		1860	1860								
		1940	1940								
				P	2,032						
		P	10	H	1,2						
		H	4,5	H ₁	0,51						
		H ₁	2,5								



MEGALINEAR PU open-end timing belts



MEGALINEAR PU open-end timing belts



MEGALINEAR open length timing belts are manufactured in thermoplastic polyurethane, that gives superior wear and abrasion resistance. Various grades of steel cords offer good running characteristics, even with high tractive loads.

Manufactured to tight tolerances, Megalinear delivers reliability and excellent dimensional stability. The addition of a Nylon coating on the tooth and/or the back of the belt during production, enhances the running properties for specific applications. An extra thickness of polyurethane is also possible on the back of the belt, offering extra protection against aggressive or heavy products.

MEGALINEAR offers the following features:

MECHANICAL features

- Consistent dimensional stability
- Low pre-tension
- Low noise
- High abrasion resistance
- Low maintenance
- High flexibility
- Linear speeds up to 80 m/sec
- High precision linear positioning

CHEMICAL features

- Good resistance to
 - Aging,
 - Hydrolisis,
 - UVA rays,
 - Ozone
- Working temperature: -25 °C to +80 °C (up to +110 °C for short periods)
- High resistance to oils, fats and greases
- Good resistance to most acids and Alkalis
- Compatible for fabrication with other thermoplastic materials

MEGALINEAR can be supplied as open length rolls, or as endless jointed belts.

OPEN LENGTH Belts

These are manufactured as continuous lengths, with the reinforcement in a parallel configuration. Standard roll lengths are 50 or 100 metres. Other lengths available on request.

MEGALINEAR belts as an open length are normally used in linear motion drives.

ENDLESS JOINTED belts

By jointing using the thermoplastic properties of the open length belt, endless belts can be produced to any length by welding. The finished joint is resistant to fatigue from flexing and tension, due to the unique symmetrical Vee shaped pattern of the joint.

Endless jointed belts are suitable for conveying applications, particularly when indexing and/or positive drive is required. Supplementary application of flights, profiles and coatings is possible, to suit specific applications.

MEGALINEAR is also available with alternative reinforcement cords such as, Kevlar (K), High Flex (HF), High Performance (HP) and High Performance Flex (HPF).



MEGALINEAR PU open-end timing belts

T2,5 - T5 - T10 - T20

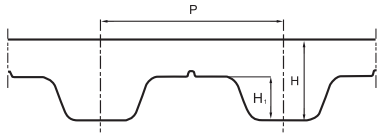

AT3 - AT5 - AT10 - AT20

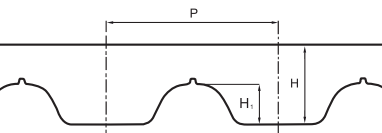

MTD 3M - MTD 5M - MTD 8M - MTD 14M

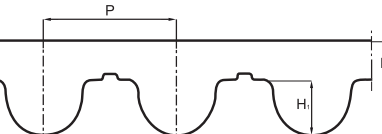

STD 5M - STD 8M

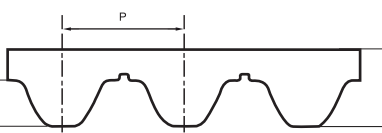

RPP5 - RPP8 - RPP14

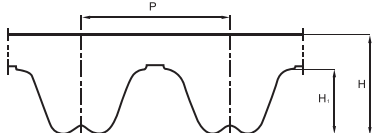

MXL - XL - L - H - XH

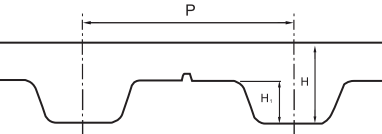

P1 - P2 - P4

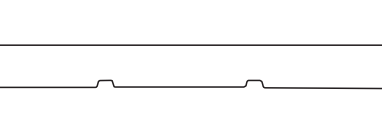

TG5 - TG10 - TG20 - ATG5 - ATG10 - ATG20 - HG

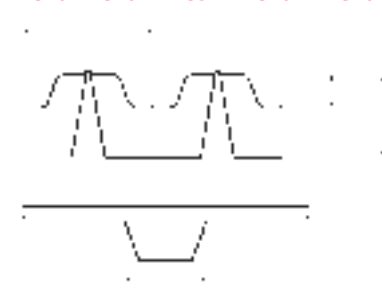

MTD 3M

Std. width (mm)
10
20
25
50

P	3
---	---

H	2,2
---	-----

H ₁	1,13
----------------	------

MTD 5M

Std. width (mm)
10
15
25
50

P	5
---	---

H	3,6
---	-----

H ₁	2,1
----------------	-----

MTD 8M

Std. width (mm)
10
15
20
30
50
85
100

P	8
---	---

H	5,6
---	-----

H ₁	3,4
----------------	-----

MTD 14M

Std. width (mm)
25
40
55
85
100
115

P	14
---	----

H	10
---	----

H ₁	6,1
----------------	-----

RPP5

Std. width (mm)
10
15
25
30
50
75

P	5
---	---

H	3,8
---	-----

H ₁	2
----------------	---

RPP8

Std. width (mm)
10
15
20
30
50
85
100

P	8
---	---

H	5,4
---	-----

H ₁	3,2
----------------	-----

RPP14

Std. width (mm)
40
55
85
115
150

P	14
---	----

H	10
---	----

H ₁	6
----------------	---

TG5 K6

Std. width (mm)
25
32
50

P	5
---	---

H	2,2
---	-----

H ₁	1,2
----------------	-----

B	6
---	---

h	4
---	---

TG10 K6

Std. width (mm)
50

P	10
---	----

H	4,5
---	-----

H ₁	2,5
----------------	-----

B	6
---	---

h	3,3
---	-----

TG10 K13

Std. width (mm)
25
32
50
75
100

P	10
---	----

H	4,5
---	-----

H ₁	2,5
----------------	-----

B	13
---	----

h	6,5
---	-----

TG20 K13

Std. width (mm)
50
75
100

P	20
---	----

H	8
---	---

H ₁	5
----------------	---

B	13
---	----

h	5,5
---	-----

ATG5 K6

Std. width (mm)
25
32
50

P	5
---	---

H	2,7
---	-----

H ₁	1,2
----------------	-----

B	6
---	---

h	4
---	---

ATG10 K13

Std. width (mm)
25
32
50
75
100
150

P	10
---	----

H	4,5
---	-----

H ₁	2,5
----------------	-----

B	13
---	----

h	7
---	---

ATG20 K13

Std. width (mm)
75
150

P	20
---	----

H	8
---	---

H ₁	5
----------------	---

B	13
---	----

h	6,4
---	-----

HG K13

Std. width (inches)
1,50
2,00
3,00
4,00

P	12,7
---	------

H	4,3
---	-----

H ₁	2,29
----------------	------

B	13
---	----

h	6,29
---	------

MEGALINEAR PU open-end timing belts

MXL		XL		L		H		H*		XH	
Std. width (inches)		Std. width (inches)		Std. width (inches)		Std. width (inches)		Std. width (inches)		Std. width (inches)	
	0.17		0.25		0.37		0.50		8.00		1.00
	0.37		0.37		0.50		0.75		20.00		1.50
	0.50		0.50		0.75		1.00				2.00
			0.75		1.00		1.50				3.00
			1.00		1.50		2.00				4.00
			1.50		2.00		3.00				6.00
			2.00		4.00		6.00				
P	2,032	P	5,08	P	9,525	P	12,7	P	12,7	P	22,225
H	1,14	H	2,3	H	3,6	H	4,3	H	4,3	H	11,2
H1	0,66	H1	1,27	H1	1,90	H1	2,29	H1	2,29	H1	6,35

T2,5		T5		T10		T10*		T20	
Std. width (mm)		Std. width (mm)		Std. width (mm)		Std. width (mm)		Std. width (mm)	
	10		6		12		200		25
	16		10		16		250		32
	20		16		25		300		50
			25		32		400		75
			32		50		450		100
			50		75		500		150
			75		100				
			100		150				
P	2,5	P	5	P	10	P	10	P	20
H	1,3	H	2,2	H	4,5	H	4,5	H	8
H1	0,7	H1	1,2	H1	2,5	H1	2,5	H1	5

AT3		AT5		AT10		AT20	
Std. width (mm)		Std. width (mm)		Std. width (mm)		Std. width (mm)	
	10		6		16		25
	20		10		25		32
	25		16		32		50
	50		25		50		75
			32		75		100
			50		100		150
			75		150		200
			100				
P	3	P	5	P	10	P	20
H	1,9	H	2,7	H	4,5	H	8
H1	1,1	H1	1,2	H1	2,5	H1	5

STD 5M		STD 8M	
Std. width (mm)		Std. width (mm)	
	10		10
	15		12
	25		15
	50		20
			30
			50
			85
P	5	P	8
H	3,4	H	5,1
H1	1,91	H1	3,05

P1		P2		P4	
Std. width (mm)		Std. width (mm)		Std. width (mm)	
	10		25		25
	20		50		50
			75		100
			100		
H	1	H	2	H	4



MEGAFLEX PU truly endless timing belts



MEGAFLEX PU truly endless timing belts



MEGAFLEX TIMING BELTS are manufactured in thermoplastic polyurethane, with continuous spiral steel cords.

This type of belt, developed by our Research & Development, offers good running characteristics and high traction loads.

They are especially suited for power transmission and conveying with high loads and high speeds (up to 10.000 RPM).

The addition of a nylon coating on the teeth during production enhances the running properties for specific applications and reduces the noise frictional coefficient.

An extra thickness of special coating is also possible on the back of the belt offering extra protection against aggressive or heavy products.

Megaflex belts are truly endless, enabling them to deliver exceptional performance.

MEGADYNE MEGAFLEX TIMING BELTS ARE AVAILABLE FROM 1.500 UP TO 22.700 mm LENGTH.



MEGAFLEX Special constructions

- High flex cords
- (NFT) nylon fabric on the teeth (available from 1.900 mm length)
- Custom milling, grinding and drilling to specification
- Additional continuous coatings on the back of the belt in:
 - PU 85° ShA
 - Tenax 50° ShA
 - Linatex 40° ShA
 - Yellow PUR 60° ShA
 - Grey PUR 60° ShA
 - Neoprene rubber 70° ShA

Other hardnesses available on request.



MEGAFLEX PU truly endless timing belts

T5 - T10 - T20

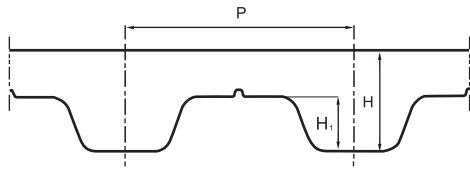

T5 DL - T10 DL - T20 DL

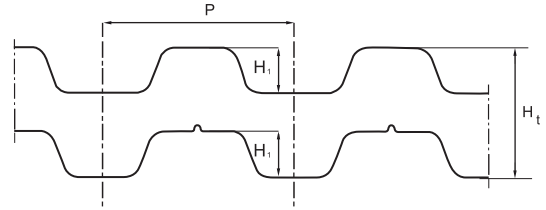

AT5 - AT10 - AT20

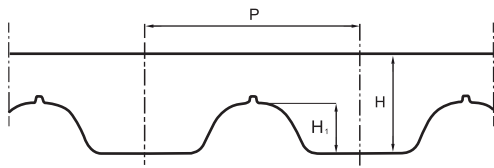

AT5 DL - AT10 DL - AT20 DL

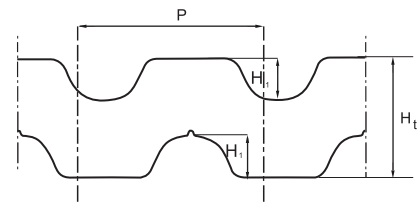

XL - L - H - XH

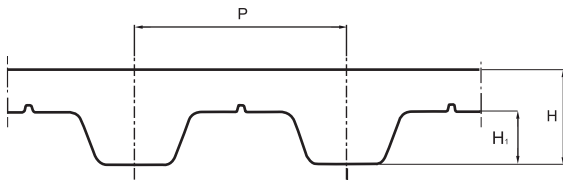

XL DL - L DL - H DL - XH DL

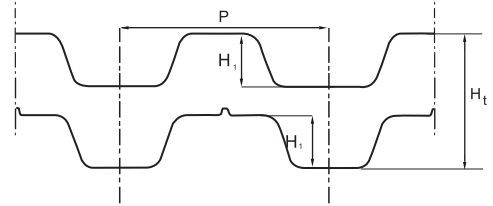

RPP5 - RPP8 - RPP14

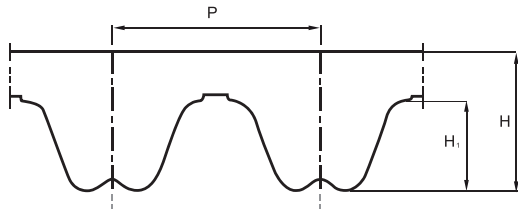

RPP5 DL - RPP8 DL - RPP14 DL

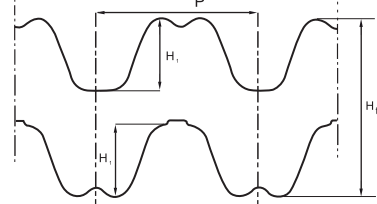

MTD 8M

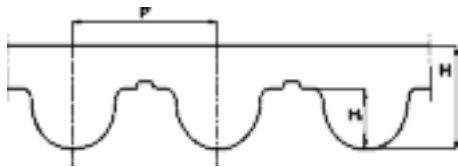

P2

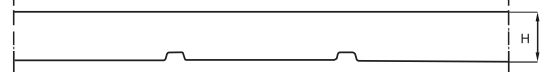

ATG10

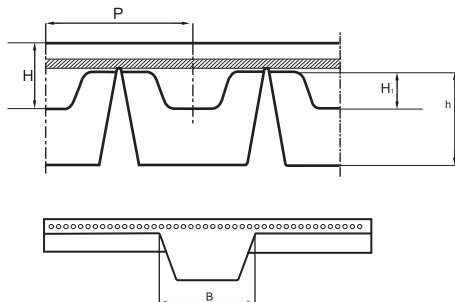

P2	ATG10 K13	MTD 8M
Std. width (mm)	Std. width (mm)	Std. width (mm)
25	10	10
50	16	16
75	25	25
100	32	32
150	50	50
	75	75
	100	100
	150	150
P 2,0	P 10	P 8
	H 4,5	H 5,6
	H1 2,5	H1 3,4
	B 13	
	h 6,4	

MEGAFLEX PU truly endless timing belts

T5/T5DL		T10/T10DL		T20/T20DL	
Std. width (mm)		Std. width (mm)		Std. width (mm)	
	10		10		10
	16		16		16
	25		25		25
	32		32		32
	50		50		50
	75		75		75
	100		100		100
	150		150		150
P	5	P	10	P	20
H	2,2	H	4,5	H	8
H ₁	1,2	H ₁	2,5	H ₁	5
H _t	3,4	H _t	7	H _t	13



AT5/AT5DL		AT10/AT10DL		AT20/AT20DL	
Std. width (mm)		Std. width (mm)		Std. width (mm)	
	10		10		10
	16		16		16
	25		25		25
	32		32		32
	50		50		50
	75		75		75
	100		100		100
	150		150		150
P	5	P	10	P	20
H	2,7	H	4,5	H	8
H ₁	1,2	H ₁	2,5	H ₁	5
H _t	3,9	H _t	7	H _t	13



RPP5/RPP5DL		RPP8/RPP8DL		RPP14/RPP14DL	
Std. width (mm)		Std. width (mm)		Std. width (mm)	
	10		10		10
	15		15		15
	20		20		20
	25		25		25
	50		50		50
	85		85		85
	100		100		100
	150		150		150
P	5	P	8	P	14
H	3,8	H	5,4	H	10
H ₁	2	H ₁	3,2	H ₁	6
H _t	5,2	H _t	7,8	H _t	14,5

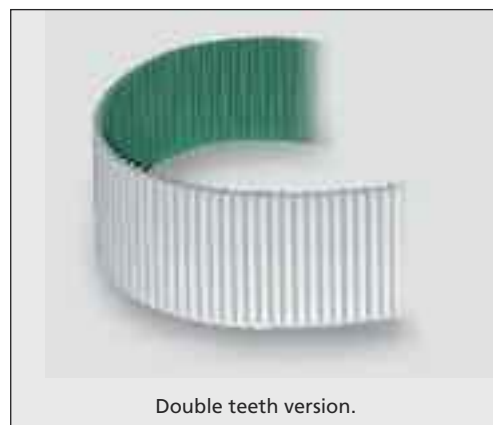

XL/XLDL		L/LDL		H/HDL		XH/XHDL	
Std. width (mm)		Std. width (mm)		Std. width (mm)		Std. width (mm)	
	12,7		12,7		12,7		12,7
	19,1		19,1		19,1		19,1
	25,4		25,4		25,4		25,4
	38,1		38,1		38,1		38,1
	50,8		50,8		50,8		50,8
	76,2		76,2		76,2		76,2
	101,6		101,6		101,6		101,6
	152,4		152,4		152,4		152,4
P	5,08	P	9,525	P	12,7	P	22,225
H	2,3	H	3,6	H	4,3	H	11,2
H ₁	1,27	H ₁	1,9	H ₁	2,29	H ₁	6,35
H _t	3,05	H _t	4,58	H _t	5,95	H _t	15,49

MEGARIB PU endless Megarib belts



MEGARIB PU endless Megarib belts



MEGARIB belts are manufactured in polyurethane with polyester high tension cords, which combine the high flexibility of flat belts with the power transmission capability of v-belts.

These belts have the following features

- Dimensional stability
- High flexibility
- Small pulley diameters
- High speeds
- Excellent oil, water and ozone resistance



The main applications are

- Food processors
- Grass cutting equipment
- Electrical household appliances
- Washing machines
- Electrical tools
- Woodworking equipment
- Domestic power tools

On request, special elastic Megarib belts can be manufactured in polyurethane with a semi-elastic tension member. They can be fitted on fix centre drives, reducing noise and vibrations. The absence of a tensioning mechanism, offers additional cost savings.

Standard Megarib belts are available in a wide variety of rib pitches and length (see below).

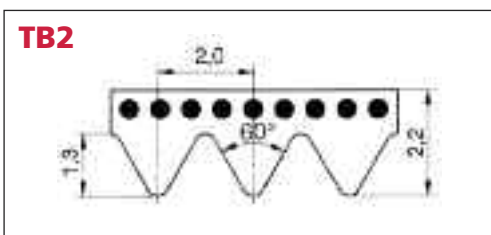
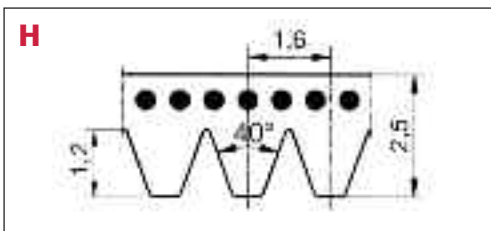
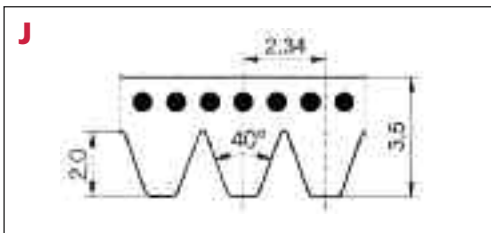

J		H	TB2
Standard length		Standard length	Standard length
(mm)	(inches)	(mm)	(mm)
220	87	223	156
271	107	261	170
275	108	295	200
278	110	330	220
283	112	340	231
288	114	375	248
304	120	389	266
330	130	400	295
345	135	410	310
356	140	485	327
381	150	507	330
392	154	588	345
406	160	602	360
431	170	609	380
444	175	650	390
457	180	768	400
483	190	935	430
508	200	1000	480
558	220	1086	510
610	240	1120	526
660	260	1163	535
681	268	1203	598
711	280	1240	630
762	300	1775	660
864	340	1976	675
914	360		725
953	376		770
1010	398		1186
1086	428		
1120	440		
1163	458		
1202	474		
1239	488		
1268	500		
1397	590		

***SPECIAL Any special pitches,
custom made coatings and profiles***



SPECIAL Any special pitches, custom made coatings and profiles



Cleat welding machine

All **SPECIAL belts** can be manufactured in a standard or coated execution, according to customer specific requirements.

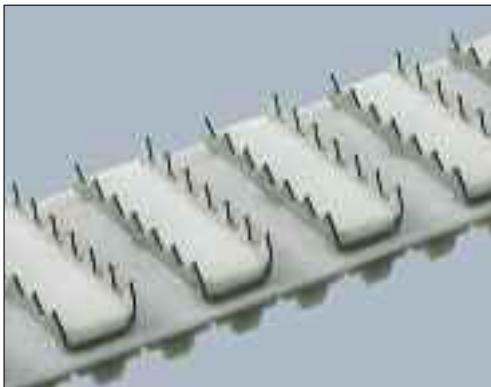

Example of belts with cleats welded on the back. Many different types of cleat are available

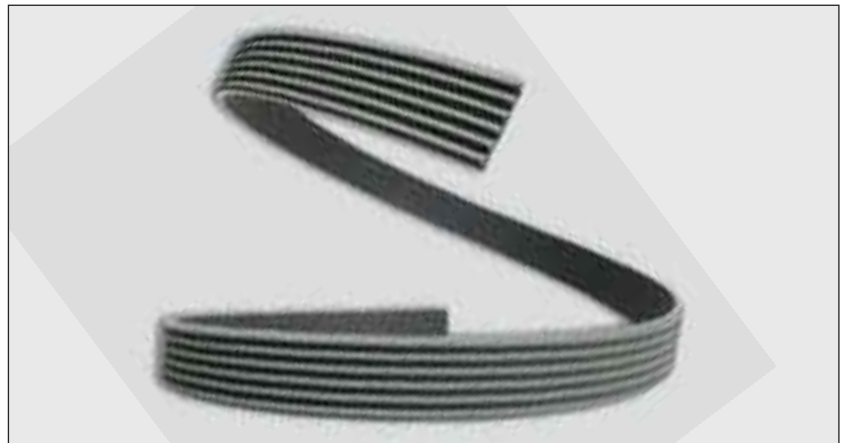

Joining press

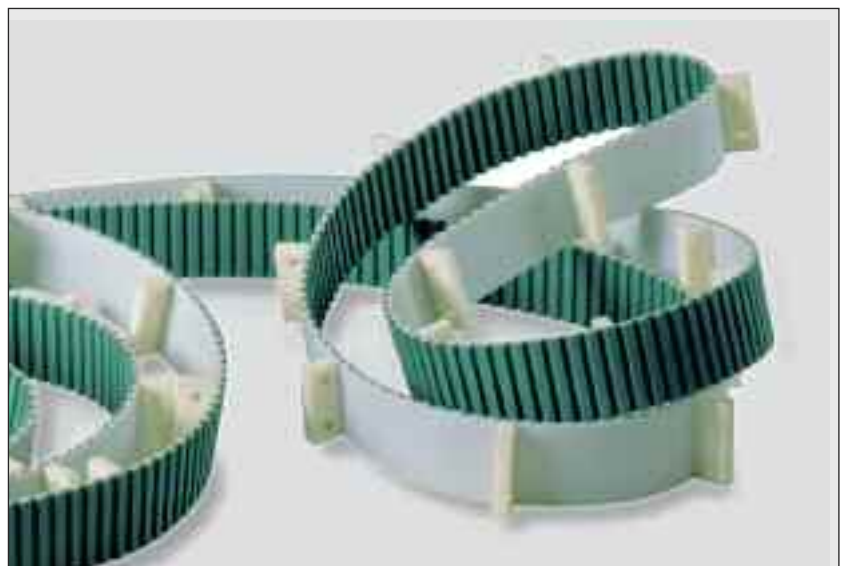

PULLEYS / CLAMPING PLATES

Custom made and standard pulleys and clamping plates



PULLEYS / CLAMPING PLATES

Custom made and standard pulleys and clamping plates

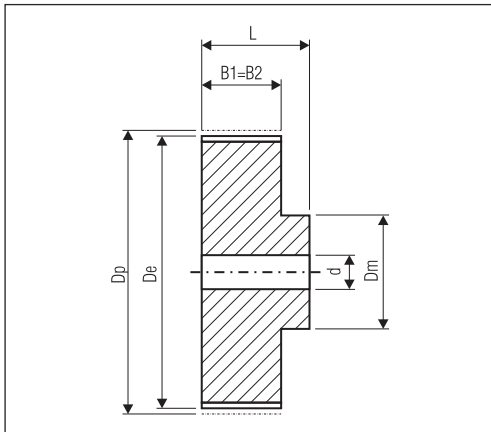

Megadyne can supply the complete drives. We can provide, either standard pulleys, made in according to ISO spec and customer specific requirements.

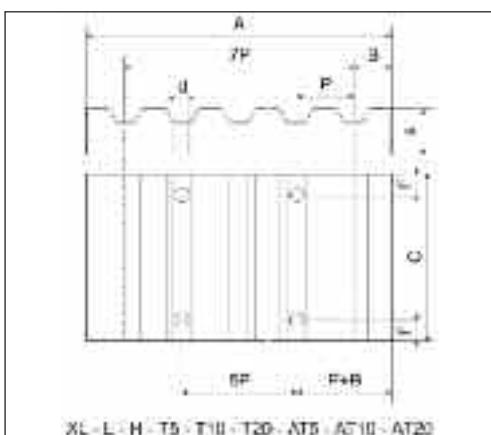
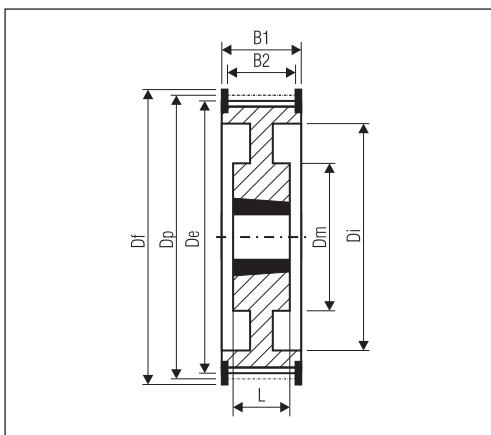
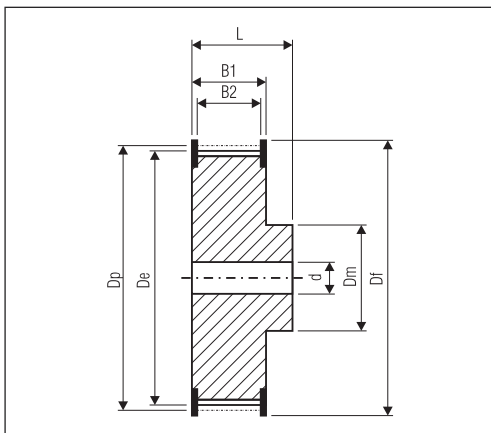

Imperial	MXL - XL - L - H - XH - XXH - HG
HTD	3M - 5M - 8M - 14M
METRIC	T2.5 - T5 - T10 - T20 - AT3 - AT5 - AT10 AT20 - TG5 - TG10 - TG20 - ATG10
RPP	RPP5 - RPP8 - RPP14

MEGAWELD Thermoweldable belts



V-belts		
Code	Hardeness	Section
PT85 / PTD85	85 ShA	Z / A / B / C / D
PT85RK / PTD85RK	85 ShA	Z / A / B / C / D
PT90 / PTD90	90 ShA	Z / A / B / C / D
PT90RK / PTD90RK	90 ShA	Z / A / B / C / D
PT100 / PTD100	100 ShA – 55 ShD	Z / A / B / C

...and more



Round belts		
Code	Hardeness	Section
PR85	85 ShA	Ø 3 ÷ 18 mm
PR85NL	85 ShA	Ø 2 ÷ 15 mm
PR85RK	85 ShA	Ø 6 ÷ 18 mm
PR90	90 ShA	Ø 2 ÷ 18 mm

...and more

Higher Tenacity Fabric & Improved Penetration of Urethane Elastomer Jason's Accu-Link® Adjustable V-Belts Are the Ideal Replacement Substitute for Conventional Rubber V-Belts.

Solve V-Belt Drive Problems Quickly, Accurately & Permanently

The ideal temporary replacement or permanent substitute for conventional rubber V-belts, Jason Industrial's Accu-Link® V-belts combine superior strength, durability and quick, easy assembly to keep equipment up and running - at the same running horse power ratings as rubber belts.

Constructed of urethane elastomer reinforced with a rugged, woven polyester fabric. Accu-Link® V-belts are manufactured by a revolutionary new process which creates smooth, precise side profiles on each link. This smooth profile creates less vibration and requires lower drive tensions for increased belt life.

Designed to fit any drive application, Accu-Link® V-belts are available in the most popular sizes - A, B and C sections in both 25' and 100' lengths. Shorter sleeved lengths are also available. What's more, Accu-Link® V-belts maintain precise tension, so they deliver maximum power on multiple-belt drives.

- Durable urethane coating Precision machined sides for smooth engagement
- Rugged, woven polyester fabric for strength and longer belt life.
- Accu-Link® cross section Ideal for Diverse Operating Environments
- Accu-Link® V-belt urethane construction offers superior resistance to most common industrial solvents and chemicals, oil, water and temperature extremes, from 40° F to 240° F.
- Accu-Link® V-belts dissipate heat so they run cooler than conventional belts.

Installation Is a Snap Installation and assembly is as easy as a snap and a twist. No special tools are required to couple or uncouple each Accu-Link® V-belt. Belts can be made to accommodate any length, which makes them ideal for emergency repairs and replacements. Once assembled, Accu-Link® V-belts install in a fraction of the time needed for endless rubber belts. Accu-Link® V-belts install in minutes without removing outboard bearings or moving motors.

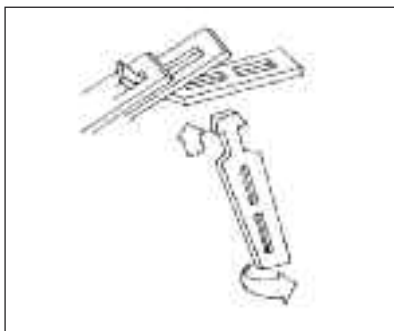

Suited to harsh environments, Accu-Link® V-belts are ideal for the metal processing, machine tool, agricultural, packaging, coal and aggregate, pulp and paper, lumber, marine, air moving, petrochemical, woodworking, conveying and food industries, HVAC.

Choose Accu-Link® For:

- Durability
- Easy Assembly
- Fast Installation
- Maximum Horsepower
- Dependability

THE NEW REVOLUTION IN THE FIELD OF CONVEYOR TRANSMISSIONS

Technical features:

- Created to allow the jointing of belts directly on the machine
- Allows a very fast belts' replacement
- Compatible with all types of coatings
- The back of the belts is virtually flat
- Direct interchangeability with joined belts that share the same geometry

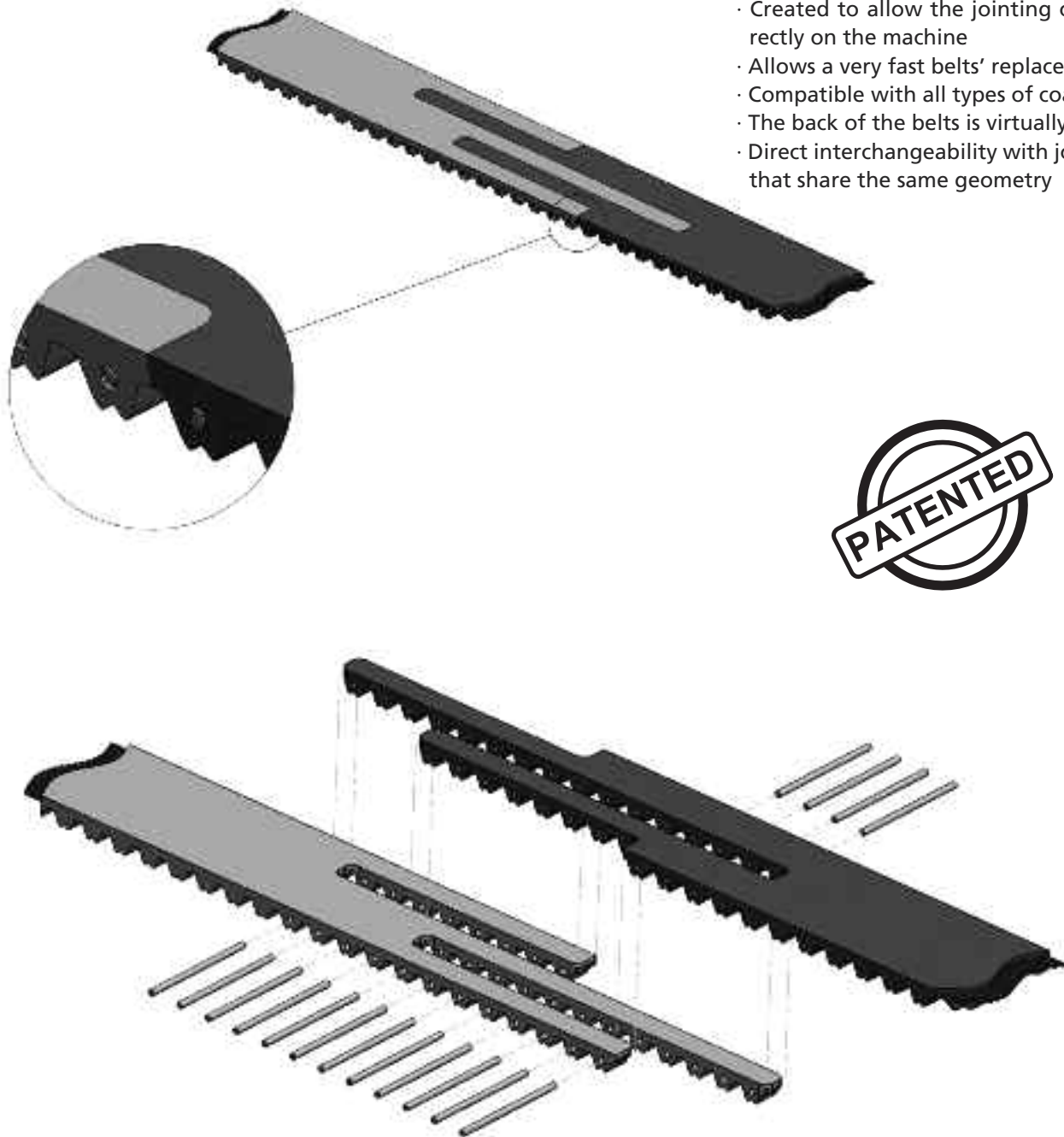

STOP to maintenance shutdowns

Available for the belt pitches T10, AT10, RPP8 ... and more, in different widths.

По вопросам продаж и поддержки обращайтесь:

Архангельск (8182)63-90-72	Калининград (4012)72-03-81	Нижний Новгород (831)429-08-12	Смоленск (4812)29-41-54
Астана +7(7172)727-132	Калуга (4842)92-23-67	Новокузнецк (3843)20-46-81	Сочи (862)225-72-31
Белгород (4722)40-23-64	Кемерово (3842)65-04-62	Новосибирск (383)227-86-73	Ставрополь (8652)20-65-13
Брянск (4832)59-03-52	Киров (8332)68-02-04	Орел (4862)44-53-42	Тверь (4822)63-31-35
Владивосток (423)249-28-31	Краснодар (861)203-40-90	Оренбург (3532)37-68-04	Томск (3822)98-41-53
Волгоград (844)278-03-48	Красноярск (391)204-63-61	Пенза (8412)22-31-16	Тула (4872)74-02-29
Вологда (8172)26-41-59	Курск (4712)77-13-04	Пермь (342)205-81-47	Тюмень (3452)66-21-18
Воронеж (473)204-51-73	Липецк (4742)52-20-81	Ростов-на-Дону (863)308-18-15	Ульяновск (8422)24-23-59
Екатеринбург (343)384-55-89	Магнитогорск (3519)55-03-13	Рязань (4912)46-61-64	Уфа (347)229-48-12
Иваново (4932)77-34-06	Москва (495)268-04-70	Самара (846)206-03-16	Челябинск (351)202-03-61
Ижевск (3412)26-03-58	Мурманск (8152)59-64-93	Санкт-Петербург (812)309-46-40	Череповец (8202)49-02-64
Казань (843)206-01-48	Набережные Челны (8552)20-53-41	Саратов (845)249-38-78	Ярославль (4852)69-52-93

Сайт: <http://techkomplekt.nt-rt.ru> || Эл. почта: isr@nt-rt.ru